



▶ Polycom® RMX®
1500/2000/4000
Getting Started Guide

Trademark Information

Polycom®, the Polycom “Triangles” logo, and the names and marks associated with Polycom’s products are trademarks and/or service marks of Polycom, Inc., and are registered and/or common-law marks in the United States and various other countries.

All other trademarks are the property of their respective owners.

Patent Information

The accompanying product is protected by one or more U.S. and foreign patents and/or pending patent applications held by Polycom, Inc.

© 2010 Polycom, Inc. All rights reserved.

Polycom, Inc.
4750 Willow Road
Pleasanton, CA 94588-2708
USA

No part of this document may be reproduced or transmitted in any form or by any means, electronic or mechanical, for any purpose, without the express written permission of Polycom, Inc. Under the law, reproducing includes translating into another language or format.

As between the parties, Polycom, Inc., retains title to and ownership of all proprietary rights with respect to the software contained within its products. The software is protected by United States copyright laws and international treaty provision. Therefore, you must treat the software like any other copyrighted material (e.g., a book or sound recording).

Every effort has been made to ensure that the information in this manual is accurate. Polycom, Inc., is not responsible for printing or clerical errors. Information in this document is subject to change without notice.

Regulatory Notices

United States Federal Communication Commission (FCC)

Part 15: Class A Statement. This equipment has been tested and found to comply with the limits for a Class A digital device, pursuant to Part 15 of the FCC Rules. Test limits are designed to provide reasonable protection against harmful interference when the equipment is operated in a commercial environment. This equipment generates, uses and can radiate radio-frequency energy and, if not installed and used in accordance with the instruction manuals, may cause harmful interference to radio communications. Operation of this equipment in a residential area is likely to cause harmful interference, in which case the user will be required to correct the interference at his or her own expense.

Part 68: Network Registration Number. This equipment is registered with the FCC in accordance with Part 68 of the FCC Rules. This equipment is identified by the FCC registration number.

If requested, the FCC registration Number and REN must be provided to the telephone company.

Any repairs to this equipment must be carried out by Polycom Inc. or our designated agent. This stipulation is required by the FCC and applies during and after the warranty period.

United States Safety Construction Details:

- All connections are indoor only.
- Unit is intended for RESTRICTED ACCESS LOCATION.
- Unit is to be installed in accordance with the National Electrical Code.
- The branch circuit overcurrent protection shall be rated 20 A for the AC system.
- This equipment has a maximum operating ambient of 40°C, the ambient temperature in the rack shall not exceed this temperature.

To eliminate the risk of battery explosion, the battery should not be replaced by an incorrect type. Dispose of used batteries according to their instructions.

CE Mark R&TTE Directive

Polycom Inc., declares that the Polycom RMX™ 2000 is in conformity with the following relevant harmonized standards:

EN 60950-1:2001

EN 55022: 1998+A1:2000+A2:2003 class A

EN 300 386 V1.3.3: 2005

Following the provisions of the Council Directive 1999/CE on radio and telecommunication terminal equipment and the recognition of its conformity.

Canadian Department of Communications

This Class [A] digital apparatus complies with Canadian ICES-003.

Notice: The Industry Canada label identifies certified equipment. This certification means that the equipment meets telecommunication network protective, operational and safety requirements as prescribed in the appropriate Terminal Equipment Technical Requirements document(s). The Department does not guarantee the equipment will operate to the user's satisfaction.

Before installing this equipment, users should ensure that it is permissible to be connected to the facilities of the local telecommunications company. The equipment must also be installed using an acceptable method of connection. The customer should be aware that compliance with the above conditions may not prevent degradation of service in some situations. Repairs to certified equipment malfunctions, may give the telecommunications company causes to request the user to disconnect the equipment.

Users should ensure for their own protection that the electrical ground connections of the power utility, telephone lines and internal metallic water pipe system, if present, are connected together. This precaution may be particularly important in rural areas.

Caution: Users should not attempt to make such connections themselves, but should contact the appropriate electric inspection authority, or electrician, as appropriate.

Regulatory Notices

Chinese Communication Certificate

声 明

此为 A 级产品，在生活环境中，该产品可能会造成无线电干扰。在这种情况下，可能需要用户对其干扰采取切实可行的措施。

Singapore Certificate

RMX 2000 complies with IDA standards G0916-07

Table of Contents

System Overview	1-1
RMX 1500/2000/4000	1-1
RMX Main Features	1-4
Conferencing Modes	1-4
Dynamic Continuous Presence	1-4
Video Switching	1-6
Operator Conference	1-7
Video Resolutions	1-7
Resolution Configuration for CP	1-7
Video Switching	1-7
H.239 / People+Content	1-8
Video Clarity™	1-8
IVR-Enabled Conferencing	1-8
PCM	1-9
Entry Queue	1-9
Conferencing Capabilities and Options	1-10
On Demand Conferencing	1-10
Permanent Conference	1-10
Scheduled Conferencing / Reservations	1-10
Polycom Conferencing for Microsoft Outlook®	1-10
Connection Methods	1-10
Cascading Conferences	1-11
Gateway	1-11
Security	1-11
Conference Management and Monitoring Features	1-12
Card Configuration Modes	1-13
Workstation Requirements	1-14
Windows 7™ Security Settings	1-15
Internet Explorer 8 Configuration	1-17
Prerequisites	1-21
First Time Installation and Configuration	2-1
Preparations	2-2
Gather Network Equipment and Address Information	2-2

IP Services	2-2
Management Network	2-2
Default IP Service (Conferencing Service)	2-2
IP Network Services Required Information	2-3
ISDN/PSTN Services	2-4
Unpacking the RMX	2-5
Unpacking the RMX 1500	2-5
Unpacking the RMX 2000	2-5
Unpacking the RMX 4000	2-5
Modifying the Factory Default Management Network Settings on the USB Key	2-8
Hardware Installation and Setup	2-9
Installing the RMX 1500	2-9
Mounting the RMX 1500 in a Rack	2-10
Connecting Cables on the RMX 1500	2-11
Installing the RMX 2000	2-12
Mounting the RMX 2000 in a Rack	2-12
Connecting Cables on the RMX 2000	2-13
Installing the RMX 4000	2-14
Mounting the RMX 4000 in a Rack	2-14
Connecting the RMX 4000 to the Power Sources	2-15
Connecting Cables on the RMX 4000	2-18
First Entry Power-up and Configuration	2-19
Procedure 1: First-time Power-up	2-19
Procedure 2: Product Registration	2-20
Obtaining the Activation Key	2-20
Procedure 3: Connection to MCU	2-21
Procedure 4: Modifying the Default IP Service and ISDN/PSTN Network Service Settings	2-22
Fast Configuration Wizard	2-23
User Definition	2-41
Selecting the RMX Web Client Languages	2-41
RMX's Default Conferencing Settings	2-42
Customizing the RMX's Default Conferencing Settings	2-45
Basic Operation	3-1
Starting the RMX Web Client	3-1

RMX 2000 Web Client Screen Components	3-3
Viewing and System Functionality Permissions	3-4
Conferences List	3-5
List Pane	3-6
RMX Management	3-6
Status Bar	3-6
System Alerts	3-7
Participant Alerts	3-7
Port Usage Gauges	3-7
MCU State	3-8
Address Book	3-9
Displaying and Hiding the Address Book	3-10
Conference Templates	3-10
Displaying and Hiding Conference Templates	3-10
Customizing the Main Screen	3-11
Customizing the RMX Management Pane	3-12
Starting a Conference	3-15
Starting a Conference from the Conferences Pane	3-16
General Tab	3-17
Participants Tab	3-21
Information Tab	3-25
Starting a Reservation	3-27
Starting an Ongoing Conference From a Template	3-29
Starting a Video Meeting from a Microsoft Outlook Polycom Meeting Invitation	3-31
Connecting to a Conference	3-32
Direct Dial-in	3-32
H.323 Participants	3-33
SIP Participants	3-33
ISDN/PSTN Participants	3-33
Connecting to a Polycom Conference from an Outlook Meeting Invitation	3-34
Entry Queue Access	3-35
H.323 Participants	3-35
SIP Participants	3-36
ISDN and PSTN Participants	3-36
Dial-out Participants	3-37

Automatic Dial Out	3-37
Gathering Phase	3-37
Gathering Phase Guidelines	3-39
Text Indication in the Video Layout	3-41
Endpoint Names	3-41
Text Indication	3-44
Transparent Endpoint Names	3-45
Permanent Display of Endpoint Names	3-45
Closed Caption	3-45
Message Overlay	3-46
Monitoring Ongoing Conferences	3-47
General Monitoring	3-47
Multi Selection	3-48
Using the Chairperson Password for Filtering	3-49
Conference Level Monitoring	3-49
Roll Call/Audible Tones During an Ongoing Conference	3-52
Audio Only Message	3-53
Secured Conference Monitoring	3-53
Monitoring Ongoing Gateway Sessions	3-54
Participant Level Monitoring	3-54
Participant Connection Monitoring	3-54
Video Preview	3-58
Operations Performed During On Going Conferences	3-60
Conference Level operations	3-60
Changing the Duration of a Conference	3-60
Adding Participants from the Address Book	3-61
Moving Participants	3-62
Saving an Ongoing Conference as a Template	3-64
Copy and Paste Conference	3-64
Copy Conference	3-64
Paste Conference	3-65
Paste Conference As	3-66
Changing the Video Layout of a Conference	3-67
Video Forcing	3-69
Enabling and Disabling Video Clarity™	3-72
Participant Level Operations	3-73
Copy Cut and Paste Participant	3-76

Copy Participant	3-76
Cut Participant	3-77
Paste Participant	3-78
Paste Participant As	3-78
Personal Layout Control with the RMX Web Client	3-81
Personal Layout Selection with Click&View	3-82
Conference Control Using DTMF Codes	3-84
Requesting Help	3-86
Personal Conference Manager (PCM)	3-87
Guidelines	3-87
PCM Interface	3-90
Initiating PCM	3-90
Remote Control Device Keys	3-91
Menu Navigation - Arrow and Zoom Keys	3-91
PCM Main Menu - Level 1	3-94
Click&View	3-94
Invite Participant	3-94
Participants Mute/Status	3-96
Camera Control	3-98
Video Force	3-99
Recording	3-100
PCM Main Menu - Level 2	3-102
Drop Participant	3-102
Terminate Conference	3-103

Appendix A - Glossary A-1

System Overview

This Getting Started Guide provides information on the installation and basic operation of your RMX system.



Chairpersons and Operators (users who start and manage conferences for other users) please read:

- *Chapter 1 – System Overview*
- *Chapter 3 – Basic Operation*

System Administrators please read:

- *Chapter 1 – System Overview*
- *Chapter 2 – First Time Installation and Configuration*
- *Chapter 3 – Basic Operation*

For more information on configuring and managing the system, refer to the *RMX 1500/2000/4000 Administrator's Guide* included with the system.



Unless specified differently, all screen captures, Diagrams and Figures included in this guide apply to RMX 1500, RMX 2000 and RMX 4000.

RMX 1500/2000/4000

The Polycom RMX 1500/2000/4000 Multipoint Control Unit (MCU) is a high performance, scalable, IP-network (H.323 and SIP) and ISDN/PSTN solution that provides the user with feature-rich and easy-to-use multipoint voice and video conferencing.

The RMX MCU meets International Telecommunication Union - Telecommunication Standardization Sector, (ITU-T, formerly CCITT) standards for multipoint multimedia bridging devices, and meets ETSI standards for telecommunication products.

The RMX unit has, in addition, been designed in compliance with IETF (Internet Engineering Task Force) – a large open international community of network designers, operators, vendors, and researchers concerned with the evolution of the Internet architecture and the smooth operation of the Internet.

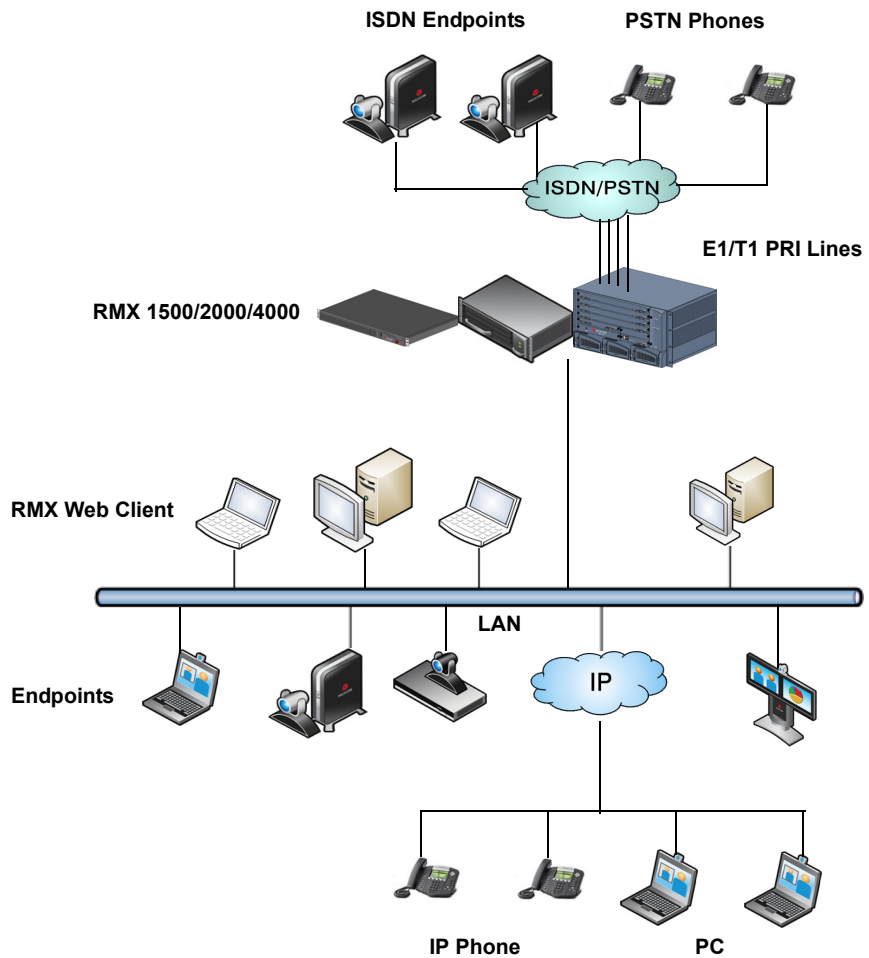

Figure 1-1 Multipoint Video Conferencing using a Polycom RMX 1500/2000/4000

The Polycom RMX 1500/2000/4000 unit can be controlled via the LAN, by the *RMX Web Client* application, using Internet Explorer® installed on the user's workstation or the RMX Manager application. The RMX Manager can control several RMX units (RMX 1500, RMX 2000 and RMX 4000). For more information about the RMX Manager, see "*RMX Manager Application*" on page **17-1**.

In the RMX 1500/2000, RMX management and IP conferencing are performed via a single LAN port. The networks can be separated in Enhanced Security Environments such as the DoD environment.

In the RMX 4000, RMX management and IP conferencing are performed via two different LAN ports. The networks can be separated in the Enhanced Security Environment.

The RMX 1500 supports one ISDN card with 4 E1/T1 PRI lines.

On the RMX 2000/4000 a maximum of two RTM ISDN cards are supported, each providing connection for up to either 7 E1 or 9 T1 PRI lines.

On RMX 1500/2000/4000, E1 and T1 connections cannot be used simultaneously.

RMX Main Features

Conferencing Modes

Dynamic Continuous Presence

The dynamic Continuous Presence (CP) capability of the RMX system enables viewing flexibility by offering multiple viewing options and window layouts for video conferencing. By default every conference, Entry Queue and Meeting Room has the ability to declare the maximum CP resolution as defined for the system. This includes conferences launched by the *RMX Web Client* and conferences started via the API.

CP mode conferencing is defined by:

- Conference profile settings:
 - Conference Line Rate.
 - Video Quality selection - Motion or Sharpness.
- Endpoint Capabilities - Participants can connect at differing line rates using endpoints with differing capabilities.

Video Layouts in CP

Thirty-five layouts are available to accommodate different numbers of participants and conference settings. The VUI annex to the H.264 protocol for endpoints that transmit wide video format instead of 4CIF resolution is also supported.

Table 1-1 Continuous Presence – Video Layouts









			
			

Table 1-1 Continuous Presence – Video Layouts (Continued)

Telepresence Mode

TPX (Telepresence) and RPX (Realpresence) room systems are configured with high definition cameras and displays that are set up to ensure that all participants share a sense of being in the same room.

The RMX enables *Telepresence Rooms* to connect to conferences where point-to-point connections cannot be used.

Additional video layouts have been created to give *Telepresence* operators more video layout options when configuring TPX room systems. These additional video layout options are available for selection when *Telepresence* is selected in the conference profile.

Multiple Switching Modes

If the number of participants is higher than the number of video windows in the selected layout, switching between video participants can be performed in one of these modes:

- Voice activation
- RMX user forces participants to selected video window
- *Lecture Mode* - The lecturer is viewed in full screen by all conference participants, while the audience is “time-switched” in the speaker’s view
- *Presentation Mode* - When the speaker’s presentation extends beyond a predefined time, he/she becomes the current lecturer and the conference switches to Lecture Mode

Video Switching

In Video Switching (VSW) mode all participants see the same video picture (full screen). Only one CIF video resource is used for each connection.

VSW mode conferencing is defined by:

- Conference *Line Rate* setting in the conference profile
 - All endpoints must connect to the conference at the same *Line Rate*. Line rates range from 192kbps to 6Mb (8Mb with MPMx). The RMX will always connect participants at the highest possible video quality the is supported by the conference *Line Rate*.
- Endpoint capabilities
 - Compliant endpoints can connect to conferences at resolutions of up to 1920 x 1080 pixels (1080p).

The video quality for the conference is determined by the *Highest Common Mechanism* and is based on the endpoint with the lowest capabilities that is connected to the conference. The *Highest Common Mechanism* enables the system to dynamically select the best video quality as endpoints connect to and disconnect from the conference.

Operator Conference

In Continuous Presence mode, a special conference that enables the RMX user, acting as an operator, to assist participants without disturbing ongoing conferences and without being heard by other conference participants. The operator can move a participant from an Entry Queue or ongoing conference to a private, one-on-one conversation in the Operator conference.

Video Resolutions

Resolution Configuration for CP

The *Resolution Configuration* dialog box enables the RMX administrator to modify the video resolution decision matrix, effectively creating his/her own decision matrix. The minimum threshold line rates at which endpoints are connected at the various video resolutions can be optimized by adjusting the resolution sliders.

For more information see the *RMX 1500/2000/4000 Administrator's Guide "Resolution Configuration"* on page [2-12](#).

Video Switching

In Video Switching (VSW) mode all participants see the same video picture (full screen). Only one CIF video resource is used for each connection.

VSW mode conferencing is defined by:

- *Conference Profile* settings:
 - *Line Rate* - From 192kbps to 6Mb (8Mb with MPMx). All participants must connect at the same line rate.
 - *Resolution* - HD720 or HD1080.
- Endpoint capabilities:
 - Participants connecting to VSW conferences must have *HD* or *SD* capable endpoints. If not, they are connected as *Secondary (Audio Only)* participants).
- **HD_THRESHOLD_BITRATE** *system flag* - determines the minimum line rate at which at which an HD channel will be opened.

H.239 / People+Content

The *H.239* protocol allows compliant endpoints to share content. By default, all *Conferences*, *Entry Queues*, and *Meeting Rooms* launched on the RMX have *H.239* capability. This protocol is also supported in *MIH Cascading* conferences.

Conferences can include a mix of endpoints that support *H.239* or *People+Content*.

People+Content is *Polycom's* proprietary equivalent of *H.239*.

Video Clarity™

The *Video Clarity* feature applies video enhancing algorithms to incoming video streams of resolutions up to and including SD. Clearer images with sharper edges and higher contrast are sent back to all endpoints at the highest possible resolution supported by each endpoint.

All layouts, including 1x1, are supported.

Video Clarity can only be enabled for *Continuous Presence* conferences in *MPM+* and */MPMx Modes*.

IVR-Enabled Conferencing

Interactive Voice Response (IVR) is a software module that automates the connection process and lets participants perform various operations during ongoing conferences. The participants use their endpoints' keypads and remote control to interact with the conference's menu-driven scripts using DTMF codes.

Operations that can be performed by participants or chairpersons during a conference include:

- Manually terminate the conference.
- Mute or unmute the participant's audio channel.
- Adjust the participant's broadcasting and listening audio volume.
- Play the Help menu.
- Mute or unmute undefined dial-in participants upon their connection to the conference.
- Request a Roll Call and stop the Roll Call names review

- Secure and unsecure a conference.
- Request individual and conference assistance.

PCM

The *Personal Conference Manager (PCM)* interface enables the conference chairperson to control various conference features using his/her endpoint's remote control device.

The following conference operations can be performed:

- Initiate **Polycom's Click&View™** application to change the local screen layout.
- Invite a participant to connect to the conference.
- View and control the audio and video of each connected endpoint.
- Camera Control - control the camera of a remote endpoint using (FECC).
- Control the camera of a connected endpoint.
- Video Force a specific participant to a specific window of the video layout.
- Initiate and control recording of the conference.
- Disconnect a participant.
- Terminate the conference.

Entry Queue

An Entry Queue is a special routing lobby for video and audio participants. After dialing the Entry Queue ID or dial-in number (ISDN/PSTN), voice prompts from an IVR service are used to connect the participants to the appropriate conference.

This service can also be used (if required) to verify the participant's right to start an Ad Hoc conference or to join an ongoing conference.

Conferencing Capabilities and Options

On Demand Conferencing

The following options are available to set up conferences:

- *New Conference* – set up once, use once.
The conference is deleted from the MCU after it ends.
- *Meeting Rooms* – set up once, use many times.
Meeting Rooms are saved in memory (using no resources) and can be activated as many times as needed.
- *Ad Hoc Entry Queue* – no setup, a new conference can be created when a user dials in and enters a conference ID that is not being used by an existing conference or Meeting Room.
- *Gateway calls* – from IP endpoints to other participants, using the direct dialing method, with up to 10 destination numbers contained in a single dial string.

Permanent Conference

A *Permanent Conference* is an ongoing conference with no predetermined *End Time*, continuing until it is terminated by an administrator, operator or chairperson.

Scheduled Conferencing / Reservations

Reservations provide calendar-based scheduling of single or recurring conferences. These conferences can be launched immediately or become ongoing, at a specified time on a specified date.

Polycom Conferencing for Microsoft Outlook®

Polycom Conferencing for Microsoft Outlook is implemented by installing the *Polycom Conferencing Add-in for Microsoft Outlook* on *Microsoft Outlook* e-mail clients. It enables meetings to be scheduled with video endpoints from within *Outlook*. The add-in also adds a *Polycom Conference* button in the *Meeting* tab of the *Microsoft Outlook* e-mail client ribbon.

Connection Methods

IPv4, IPv6, ISDN and PSTN communication protocols are supported for connection to the conference.

- Dial-out: automatically, to pre-defined participants (line rate detection is automatic)

- Dial-in:
 - for participants defined in advance (IP participants only)
 - for undefined participants directly to a conference (IP and ISDN/PSTN)
 - for undefined participants via a single dial Entry Queue (IP and ISDN/PSTN)

Cascading Conferences

- Simple Cascading of 2 MCUs and Star Topology.
- Multi Hierarchy Cascading (MIH).

Gateway

Using a special Gateway Profile, the RMX can be used as a gateway that provides connectivity across different physical networks such as H.323, SIP, ISDN and PSTN. The Gateway also provides connectivity between the ISDN/PSTN endpoints and the DMA.

Security

- Media Encryption, available at conference and participant levels, based on AES 128 Media Encryption and DH 1024 Key Exchange standards.
- Secured Communication Mode (SSL/TLS).
- Secured conferences via DTMF codes and limited monitoring of secured conferences.
- Auditor to analyze configuration changes and unusual or malicious activities in the RMX system.
- Network security can be enhanced by separation of the Signaling and Management Networks.
- RMX Users can be disabled by the administrator, or automatically when inactive. Disabled Users can be enabled by the administrator.
- Enhanced Security Environment can be implemented. In such an environment, the following attributes are implemented:
 - Password management:
 - Strong Passwords and password re-use / history rules,
 - password aging rules, password change frequency and forcing password change
 - Conference and Chairman Passwords

- Locking out Users
- Displaying the User Login record
- Controlling the User Sessions includes:
 - Limiting the maximum number of concurrent user sessions
 - Connection Timeout
 - User session timeout
 - Limiting the maximum number of users that can connect to the system

Conference Management and Monitoring Features

The Polycom RMX 1500/2000/4000 Web Client provides capabilities for management and monitoring of participants and conferences, including the following:

- *Lecture Mode or Presentation Mode* in Continuous Presence conferences.
- *Far End Camera Control (FECC/LSD)* in video conferences.
- Automatic termination of idle (no participants) conferences.
- Automatic extension of conference *Duration*.
- Control of listening and broadcasting audio volume for individual participants.
- *Auto Gain Control (AGC)* noise and audio volume regulation for individual participants.
- Conference control via *DTMF* codes from participant's endpoint or telephone.
- Entry, exit and end-of-conference indications.
- *Media Encryption*.
- Active display of all conferences and participants with option to limit display in secured conferences.
- Real-time monitoring of each participant's connection status and properties.
- Multiple drag & drop of participants.
- Easily accessed *Call Detail Records (CDR)* for administrator.
- Active display of all system resources.
- *Closed Caption* provides real-time text transcriptions or language translations of the video conference.

- *Message Overlay* allows messages to be sent to all participants in an ongoing conference.
- *PCM* enables the conference chairperson to control various conference features using his/her endpoint's remote control device.
- *Video Preview* allows RMX users to preview video sent from the participants to the conference and from the conference to the participants.
- *Auto Redial when Endpoint Drops* instructs the RMX to automatically redial IP and SIP participants that have been abnormally disconnected from the conference.
- *Operator Assistance & Participant Move* for conferences in CP mode.

Card Configuration Modes

Three *Card Configuration Modes* are supported:

- **MPM Mode** – Supported with *MPM cards* on the current, and all previous RMX versions. *Applicable to RMX 2000 only.*
- **MPM+ Mode** – Supported from Version 4.0, with *MPM+ cards* installed in the RMX 2000 and RMX 4000. It offers:
 - Two *Video/Voice Resource Capacity* resource allocation modes for increased control over system resource allocation.
 - Enhanced *Resource Report* for more accurate system management.
 - Additional video resolutions and video quality.
- **MPMx Mode** – Supported from Version 7.0, with *MPMx cards* installed in the RMX 1500 and RMX 4000. Over and above *MPM+* it offers:
 - Increased resource capacity.
 - Additional symmetric *HD* resolutions.
 - H.264 High Profile.
 - Additional line rates.

Workstation Requirements

The *RMX Web Client* and *RMX Manager* applications can be installed in an environment that meets the following requirements:

- **Minimum Hardware** – Intel® Pentium® III, 1 GHz or higher, 1024 MB RAM, 500 MB free disk space.
- **Workstation Operating System** – Microsoft® Windows® XP, Vista®, Windows® 7.
- **Network Card** – 10/100 Mbps.
- **Web Browser** – Microsoft® Internet Explorer® Version 6 or higher.



.Net Framework 2.0 is required and installed automatically.
If ActiveX installation is blocked please see the *RMX 1500/2000/4000 Administrator's Guide*, "ActiveX Bypass" on page **18-113**.



When installing the *RMX Web Client*, Windows Explorer >Internet Options> Security Settings must be set to *Medium* or less.

Windows 7™ Security Settings

If *Windows 7* is installed on the workstation, *Protected Mode* must be disabled before downloading the Version 7.0 software to the workstation.

To disable Protected Mode:

- 1 In the *Internet Options* dialog box, click the **Security** tab.

The **Security** tab is displayed.

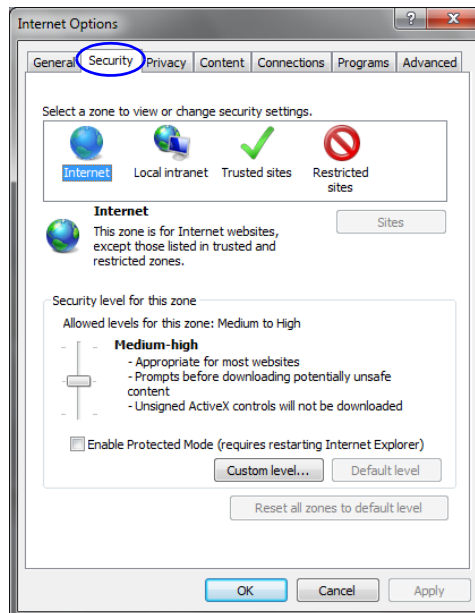

2 Clear the *Enable Protected Mode* check box for each of the following tabs:

- *Internet*
- *Local intranet*
- *Trusted sites*

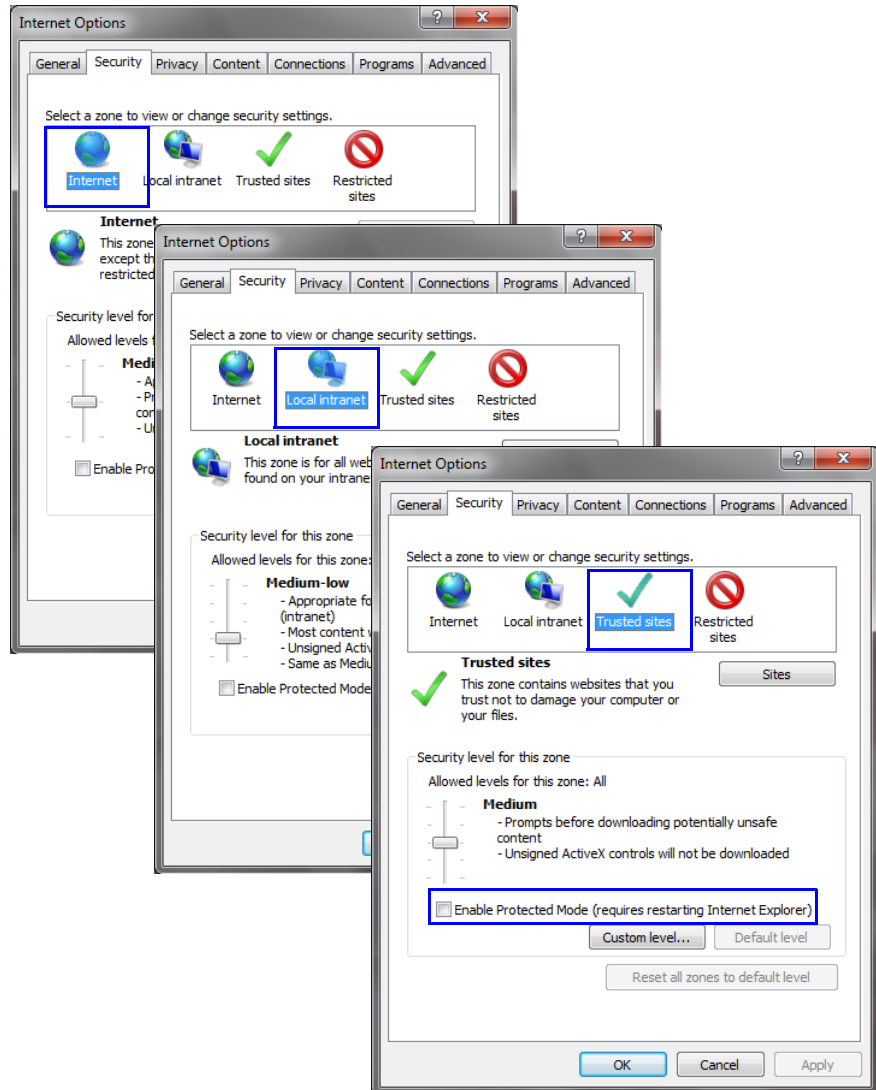

- 3 After successful connection to *RMX*, the *Enable Protected Mode* check boxes can be selected to enable *Protected Mode* for the following tabs:
 - *Internet*
 - *Local intranet*

Internet Explorer 8 Configuration

When using *Internet Explorer 8* to run the *RMX Web Client* or *RMX Manager* applications, it is important to configure the browser according to the following procedure.

To configure Internet Explorer 8:

- 1 Close **all** browsers running on the workstation.
- 2 Use the *Windows Task Manager* to verify that no *iexplore.exe* processes are running on the workstation. If any processes are found, use the **End Task** button to end them.
- 3 Open *Internet Explorer* but do **not** connect to the *RMX*.
- 4 In the *Internet Explorer* menu bar select **Tools >> Internet Options**.

The *Internet Options* dialog box is displayed with *General* tab open.

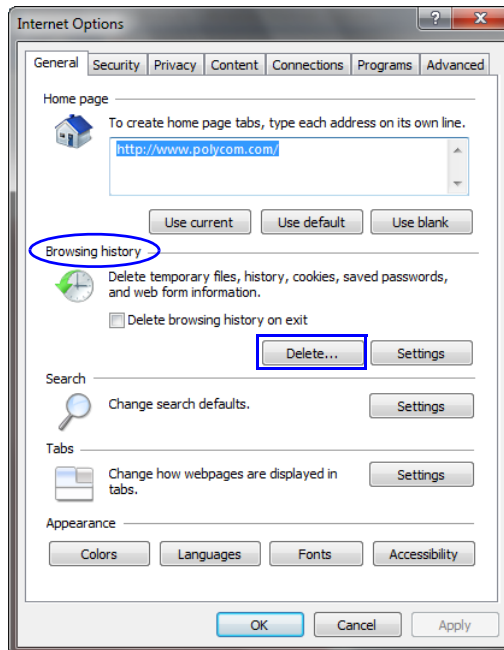

- 5 In the *Browsing history* section, click the **Delete** button.

The *Delete Browsing History* dialog box is displayed.

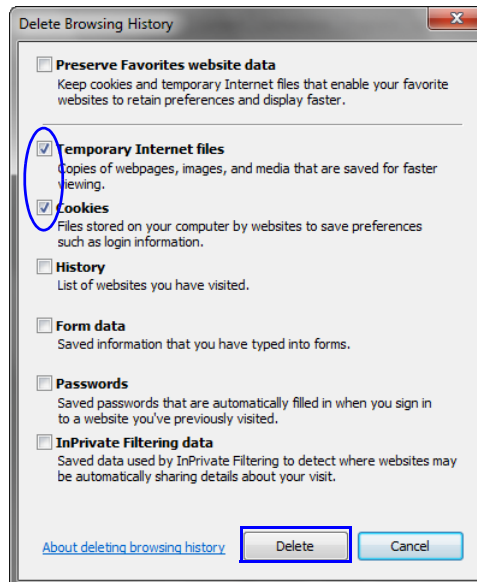

- 6 Select the **Temporary Internet** files and **Cookies** check boxes.
- 7 Click the **Delete** button.
- 8 The *Delete Browsing History* dialog box closes and the files are deleted.
- 9 In the *Internet Options* dialog box, click the **Settings** button.

The *Temporary Internet Files and History Settings* dialog box is displayed.

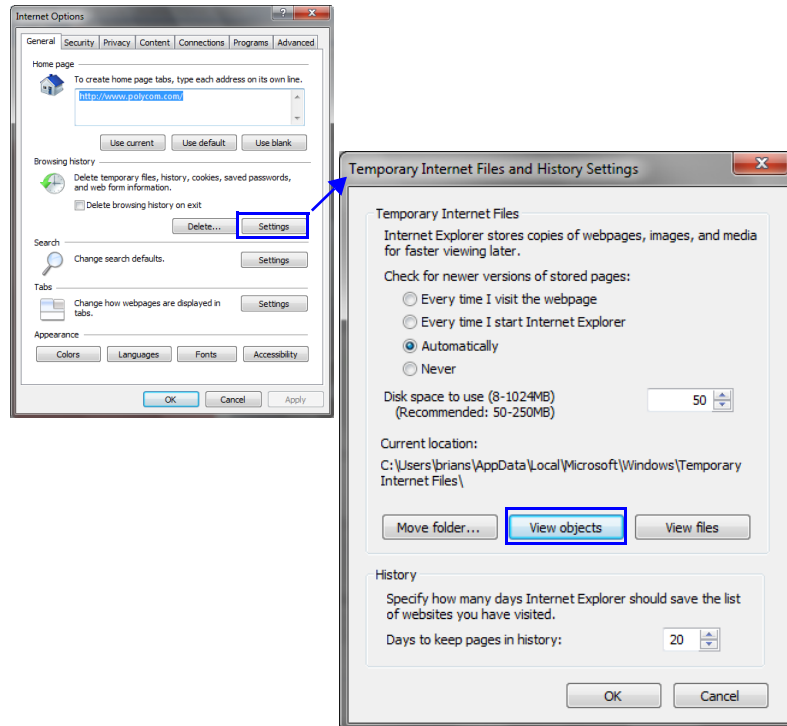

10 Click the **View objects** button.

The *Downloaded Program Files* folder containing the installed *Program Files* is displayed.

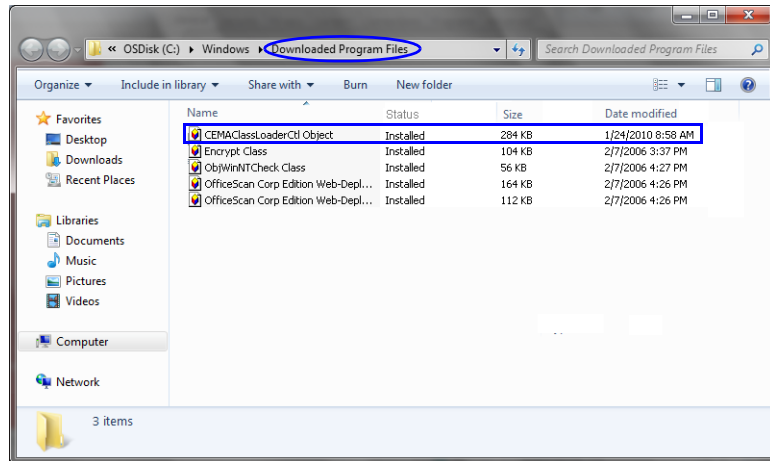

- 11 Select the *CEMAClassLoaderCtrl Object* file
- 12 Press the **Delete** key on the workstation.
- 13 Close the *Downloaded Program Files* folder and the *Temporary Internet Files and History Settings* dialog box.
- 14 In the *Internet Options* dialog box, click the **OK** button to save the changes and close the dialog box.

Prerequisites

This manual assumes the user has the following knowledge:

- Familiarity with Windows® XP or Vista® operating systems and interface.
- Familiarity with Microsoft® Internet Explorer® Version 6 or higher.
- Basic knowledge of video conferencing concepts and terminology.

First Time Installation and Configuration

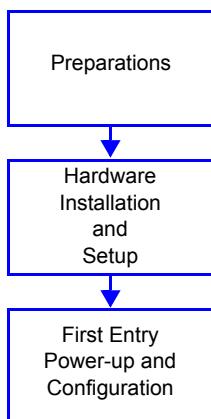

First Time Installation and Configuration of the Polycom RMX 1500/2000/4000 consists of the following procedures:

1 Preparations:

- Gather Network Equipment and Address Information - get the information needed for integrating the RMX into the local network.
- Unpack the RMX.
- Modify the *Management Network parameters* on the USB Key.

2 Hardware Installation and Setup

- Mount the RMX in a rack.
- Connect the necessary cables.

3 First Entry Power-up and Configuration

- Power up the RMX.
- Register the RMX.
- Connect to the RMX
- Configure the *Default IP Network Service*.
- Configure the *ISDN/PSTN Network Service*.

Preparations

Gather Network Equipment and Address Information

IP Services

The IP addresses and network parameters which enable communication between the RMX, its management application and the conferencing devices are organized in two IP services:

- **Management Network (Control Unit)**
- **Default IP Service (Conferencing Service)**

During the *First Entry Configuration*, the parameters of these two network services are modified to comply with your local network settings.

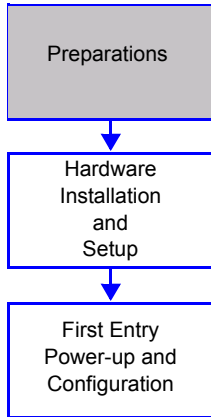

Management Network

The *Management Network* enables communication between the RMX *Control Unit* and the *RMX Web Client* and is used to manage the RMX.

The RMX is shipped with default IP addresses as listed in Table 2-1.

Management Network Definition

The definition of the Management Network can be done by two methods:

- **USB key (recommended method)** – The system is shipped with a *USB key* containing the default IP addresses for the control unit and the shelf management.

These defaults are first modified in the PC and then uploaded to the RMX.

- **Direct connection** – Creating a private network between the RMX and the computer and modifying the management network parameters using *Fast Configuration Wizard* in the *RMX Web Client*. For more information, see the *RMX 1500/2000/4000 Administrator's Guide*, "Configuring Direct Connections to RMX" on page **G-1**.

Default IP Service (Conferencing Service)

The *Default IP Service (Conferencing Service)* is used to configure and manage communications between the RMX and conferencing devices.

IP Network Services Required Information

When installing an RMX unit, these default IP addresses must be modified to your local network settings. Therefore it is important that before powering the RMX unit up for the first time, that you obtain the information needed to complete the **Local Network Settings** section of the table from your network administrator.

For *RMX 1500*, the network administrator should allocate three *IP* addresses in the local network for an *MCU* with a *MPM_x* card.

For *RMX 2000*, the network administrator should allocate four *IP* addresses in the local network for an *MCU* with one *MPM/MPM+/MPM_x* card and five *IP* addresses for an *MCU* with two *MPM/MPM+/MPM_x* cards.

For *RMX 4000*, the network administrator should allocate four *IP* addresses in the local network for an *MCU* with one *MPM+/MPM_x* card and up to seven *IP* addresses for an *MCU* with up to four *MPM+/MPM_x* cards.

Table 2-1 Network Equipment and Address Information

Parameter	Factory Default	Local Network Settings
<i>Control Unit IP Address</i>	192.168.1.254	
<i>Control Unit Subnet Mask</i>	255.255.255.0	
<i>Default Router IP Address</i>	192.168.1.1	
<i>Shelf Management IP Address</i>	192.168.1.252	
<i>Signaling Host IP address</i>	–	
<i>Media Board IP address (MPM 1)</i>	–	
<i>Media Board IP address (MPM 2)</i> RMX 2000/4000 only	–	

Table 2-1 Network Equipment and Address Information (Continued)

Parameter	Factory Default	Local Network Settings
Media Board IP address (MPM 3) RMX 4000 only	–	
Media Board IP address (MPM 4) RMX 4000 only	–	
Gatekeeper IP address (optional)	–	
DNS IP address (optional)	–	
SIP Server IP address (optional)	–	

ISDN/PSTN Services

The ISDN/PSTN Network Service is used to define the properties of the ISDN/PSTN switch and the ISDN lines running from the ISDN/PSTN switch to the ISDN card installed in the RMX.

Before configuring the ISDN/PSTN Network Service, obtain the following information from your ISDN/PSTN Service Provider:

- Switch Type
- Line Coding and Framing
- Numbering Plan
- Numbering Type
- Dial-in number range



If the RMX is connected to the public ISDN Network, an external CSU or similar equipment is needed.

Unpacking the RMX

Unpacking the RMX 1500

To unpack and lift the RMX 1500:

- 1 When you receive the RMX 1500 packing case, inspect the equipment for damage and verify that the components match the packing slip.
- 2 Open the top cover of the RMX 1500 packing case and make sure that the *Installation Accessories* kit contains the power cables and a USB Key.
- 3 Remove the top cover, lift the RMX 1500 from the package and place it on a flat surface.



Write down the RMX's serial number that is on a sticker on the back of the unit. It will be needed for product registration later in the process.

Unpacking the RMX 2000

To unpack and lift the RMX 2000:

- 1 When you receive the RMX 2000 packing case, inspect the equipment for damage and verify that the components match the packing slip.
- 2 Open the top cover of the RMX 2000 packing case and make sure that the *Installation Accessories* kit contains the power cables and a USB Key.
- 3 Remove the top cover, lift the RMX 2000 from the package and place it on a flat surface.



Write down the RMX's serial number that is on a sticker on the back of the unit. It will be needed for product registration later in the process.

Unpacking the RMX 4000

To unpack and lift the RMX 4000:

- 1 When you receive the RMX 4000 packing case, inspect the equipment for damage and verify that the components match the packing slip.
- 2 The RMX 4000 is shipped in a packing case with Stratocell® packaging, and the top cover must be unlocked and lifted.
- 3 Open the top cover of the packing case.

Two boxes are placed on the top Stratocell®, labelled:

- *Installation Accessories*. This kit contains the power cables and a Disk-on Key (DOK).
- *Rack Installation Accessories*. This kit contains the accessories for the 19" & 23" racks as follows:

Table 2-2 19" & 23" Rack Installation Accessories Package

Item ID	Description	Quantity
MEC2474A-L0	Chassis runner for rack installation on the RMX 4000. 19" & 23" racks both require that these runners be installed on the rack.	2
MEC2475A-L0	23" bracket to be fitted to the front of the RMX 4000.	2

Make sure that boxes contain all the required parts.

- 4 Remove the boxes and top Stratocell® and open the anti-static plastic bag wrapping the RMX.

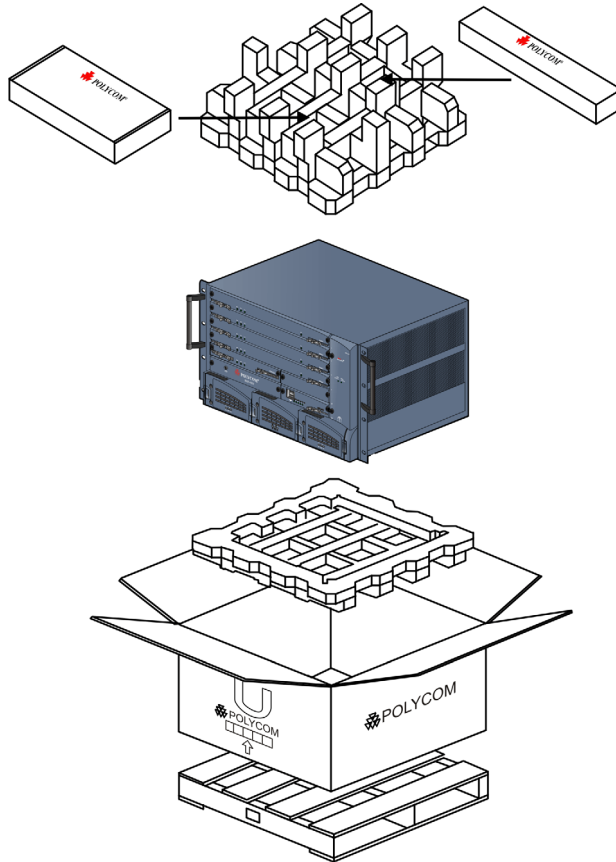

- 5 Holding the handle on each side, lift the RMX 4000 from the box, and place it on a flat surface or in a rack. Remove any packaging material prior to positioning the RMX 4000.

**Attention:**

Two people are required to lift the MCU out of the box and when installing it in a rack.



Write down the RMX's serial number that is on a sticker on the back of the unit. It will be needed for product registration later in the process.

Modifying the Factory Default Management Network Settings on the USB Key

The *USB key* contains a text file, *lan.cfg*, which holds the factory default IP address parameters. These parameters must be modified to your local network settings using the *LAN Configuration Utility*, also on the *USB key*.

To modify the USB key settings:

- 1 Take the *USB Key* from the *Installation Accessories* kit and insert it into the PC workstation and double-click **LanConfigUtility.exe** to start the utility.

The *LAN Configuration Utility* dialog box opens.

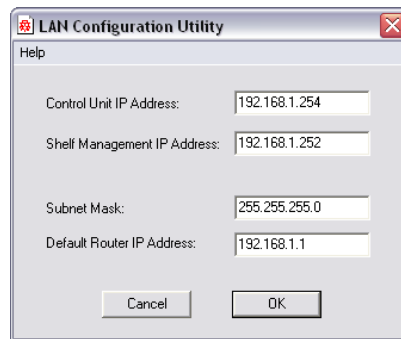

- 2 Modify the following parameters in the utility's dialog box using the information supplied by your network administrator.
 - Control Unit IP Address
 - Shelf Management IP Address
 - *Subnet Mask*
 - *Default Router IP Address*
- 3 Click **OK**.
- 4 Remove the *USB Key* from the PC.
The *USB key* is required for first entry power-up.

Hardware Installation and Setup

The *RMX 1500/RMX 2000* unit should be mounted in a 19" rack in a well ventilated area. The *RMX 4000* unit can be mounted in a 19" or 23" rack in a well ventilated area. It is important to adhere to the *Site Requirements* as described in the *RMX 1500 & RMX 1500/2000/4000 Hardware Guides, "Site Requirements"* on page **1-3**.

Installing the RMX 1500



For detailed instructions, precautions and requirements for installing the *RMX 1500* refer to the *Polycom RMX 1500 Hardware Guide*.

The following procedures have to be performed to install the *RMX 1500* in your site:

- Installing the *RMX* in a rack or as a standalone
- Connecting the *RMX 1500* to the power source
- Connecting the network (*LAN, IP* and *ISDN*) cables to the *RMX*.

Mounting the RMX 1500 in a Rack

There are two methods for installing the RMX in a 19" rack:

- **Using rack brackets on the RMX 1500**– Install rack brackets, supplied by the rack manufacturer, in the rack. Mount the RMX 1500 on top of the rack brackets. Fasten the RMX to the rack with screws through the four holes in the RMX's front mounting brackets.

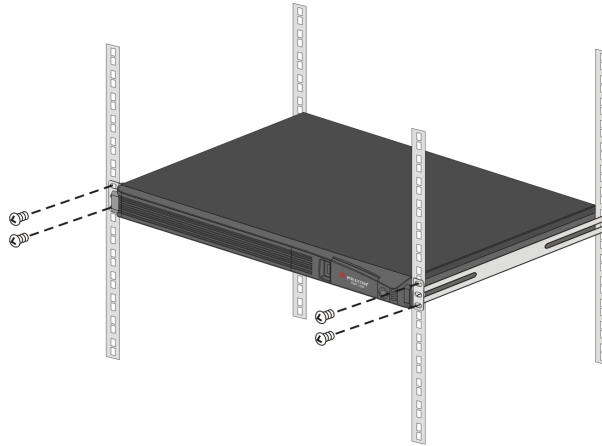

- **Using a shelf** – Install the shelf, supplied by the rack manufacturer, in the rack. Mount the RMX on the shelf. Fasten the RMX to the rack with screws through the four holes in the RMX's front mounting brackets.

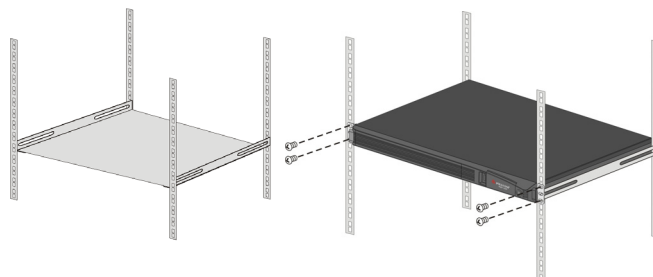

Connecting Cables on the RMX 1500

To connect the cables:

- For the **RTM-IP 1500 module**:
 - Connect the Media cable to **LAN 2** port.
 - Connect the Network cables to the **MNG** (*Signaling*) port & **MNGB** (*Management Network*) port.
 - (Optional) Connect the *Shelf Management* cable to the **Shelf** port.
- For the **RTM ISDN 1500 module**:
 - Connect the E1/T1 cables to their **PRI (1-4)** ports.

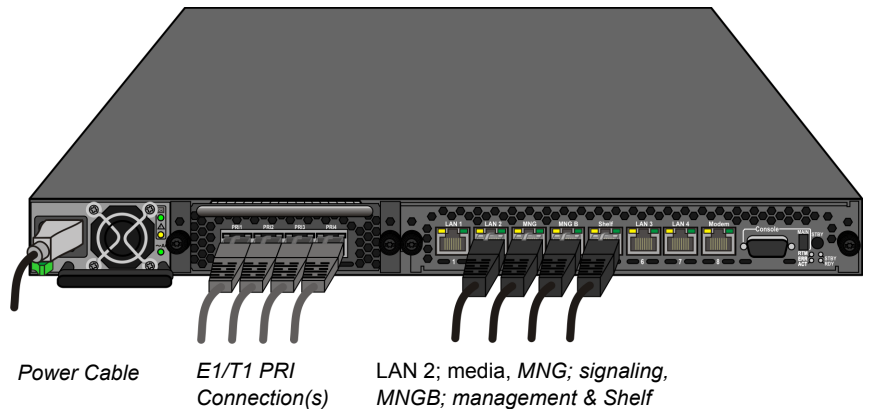

Figure 2-1 RMX 4000 Rear Panel View with AC Power and Communication Cables



The LAN 1, LAN3, LAN4 and Modem ports are not be used and the plastic caps covering those ports should not be removed.

Installing the RMX 2000



For detailed instructions, precautions and requirements for installing the RMX 2000 refer to the Polycom RMX 2000 Hardware Guide.

- The following procedures have to be performed to install the RMX 2000 in your site:
- Installing the RMX in a rack or as a standalone
- Connecting the RMX 2000 to the power source
- Connecting the network (LAN, IP and ISDN) cables to the RMX

Mounting the RMX 2000 in a Rack

There are two methods for installing the RMX in a 19" rack:

- **Using rack brackets on the RMX 2000**– Install rack brackets, supplied by the rack manufacturer, in the rack. Mount the RMX 2000 on top of the rack brackets. Fasten the RMX to the rack with screws through the four holes in the RMX's front mounting brackets.

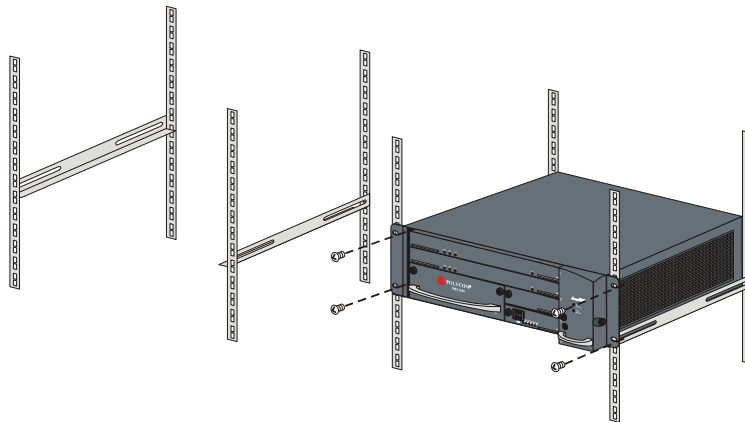

- **Using a shelf** – Install the shelf, supplied by the rack manufacturer, in the rack. Mount the RMX on the shelf. Fasten the RMX to the rack with screws through the four holes in the RMX's front mounting brackets.

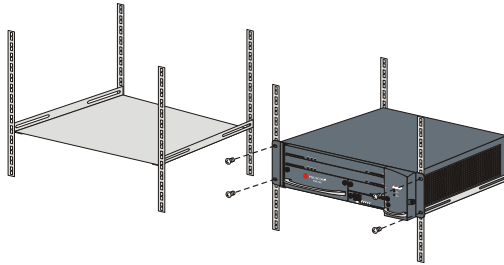

Connecting Cables on the RMX 2000



Do not remove the protective caps from LAN1, LAN3 and ShMG ports.

Connect the following cables to the back panel:

- Power cable
- LAN cable to **LAN 2** Port
- E1/T1 Cables to **PRI** Ports

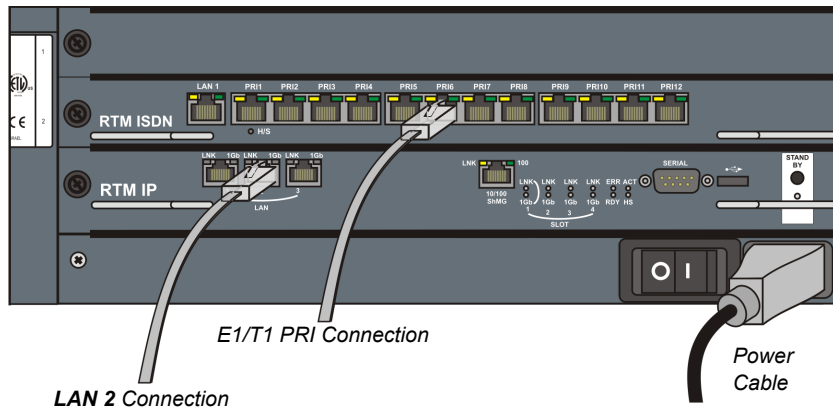

To maximize conferencing performance, especially in high bit rate call environments, a 1Gb connection is recommended.

Installing the RMX 4000

The following procedures have to be performed to install the RMX 4000 in your site:

- Mounting the RMX in a rack
- Connecting the RMX 4000 to the power source
- Connecting the network (LAN, IP and ISDN) cables to the RMX

Mounting the RMX 4000 in a Rack

Either place the RMX 4000 on a hard, flat surface such as a desktop or mount it on a 19"/23" rack.



For a detailed description of the safety requirements and precautions and the installation of the RMX 4000 as a standalone, in a 23" rack, or reverse mounting the RMX 4000 on a 19" rack, see the *RMX 4000 Hardware Guide*.

To install the RMX 4000 in a 19" rack:

- **Using rack brackets on the RMX 4000**
 - Install chassis runners supplied by Polycom, in the rack.
 - Mount the RMX 4000 on top of the rack brackets.
 - Fasten the RMX to the rack with screws through the eight holes in the RMX's front mounting brackets.
- **Using a shelf**
 - Install the shelf, supplied by the rack manufacturer, in the rack.
 - Mount the RMX on the shelf.
 - Fasten the RMX to the rack with screws through the four holes in the RMX's front mounting brackets.

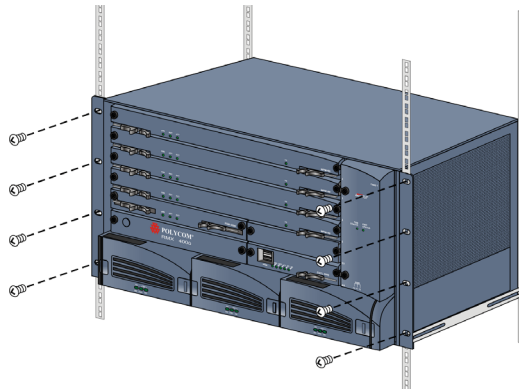

Connecting the RMX 4000 to the Power Sources



The size of the protective earthing conductor & cable should be a minimum of 10AWG.

Connect the following power cables to the RMX 4000 back panel:

AC Power Supply connections:

- 1 Insert power cables to each of the three AC Power Entry Modules (PEMs).

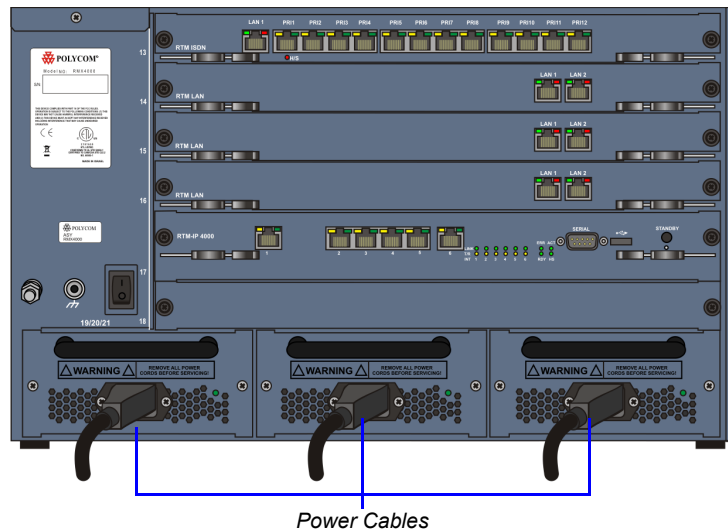

Figure 2-2 RMX 4000 Rear Panel View with AC Power

DC Power Supply connections:

- 1 On the DC Power Rail Modules set the two circuit breakers to OFF.



Two types of circuit breakers can be installed on the DC Power Rail Module (PRM). For more information, see the *RMX 4000 Hardware Guide*.

- 2 Ensure that the cables from the Main that supplies electricity to the DC power units are OFF or disconnected.

- 3** Remove the transparent plastic caps on the terminal block.
- 4** Using the two wires of an 10 AWG cable running from the DC power distribution unit, connect the black wire into the -48VDC terminal block and the red wire to the RTN terminal block.



- A 10 AWG cable must be used to connect the mains with the RMX 4000 DC Power Rail Model.
- The supply wires for DC version must be terminated using quick connectors.
- Extension cords may not be used.

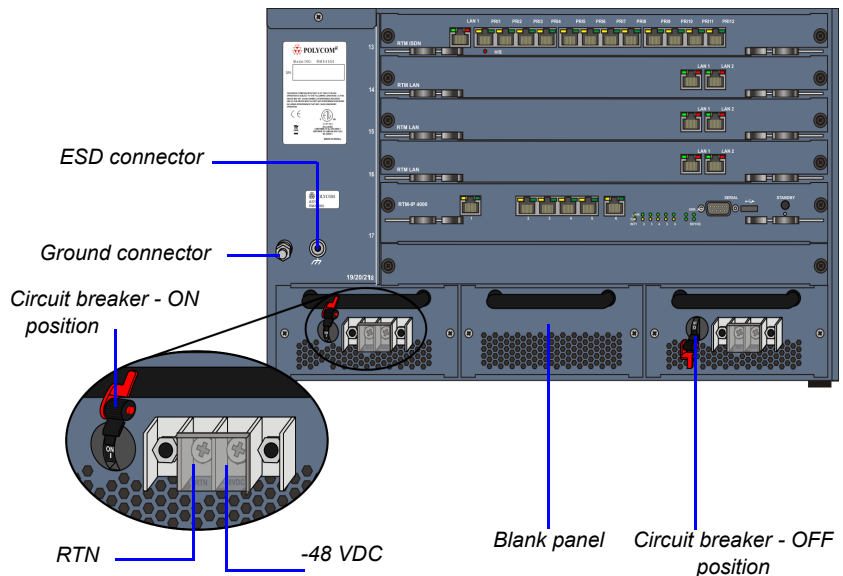

The center PRM slot/module is fitted with a blank panel and the slot cannot be used on a system with DC Voltage.

- 5** Connect the green or green-yellow wire to the system single-point M6x15 "Ground" bolt.



The rating of the protective earthing conductor should be a minimum of 10AWG.

If the unit is rack mounted, the single-point ground on the MCU must be connected to the rack with a single conductor and fixed as to prevent loosening. When using bare conductors, they must be coated with an appropriate antioxidant compound before crimp connections are made. Tinned, solder-plated or silver plated connectors do not have to be prepared in this manner.

- 6** Replace the transparent plastic caps on the terminal block.
- 7** Turn ON the Main that supplies power to the RMX.
- 8** Turn ON the circuit breaker on each of the DC Power Rail Modules.

Connecting Cables on the RMX 4000

To connect the cables (AC and DC systems):

- **RTM-IP 4000:**
 - Connect the Management Network cable to **LAN 2**.
 - Connect the Signalling cable to **LAN 3**.
 - Connect the Shelf Management cable to **LAN 6**.
- For each installed **RTM LAN** - Connect the LAN cable to **LAN 2**.
- For each installed **RTM ISDN:**
 - Connect the E1/T1 cables to their **PRI** Ports.
 - Connect the LAN cable to **LAN 1**.

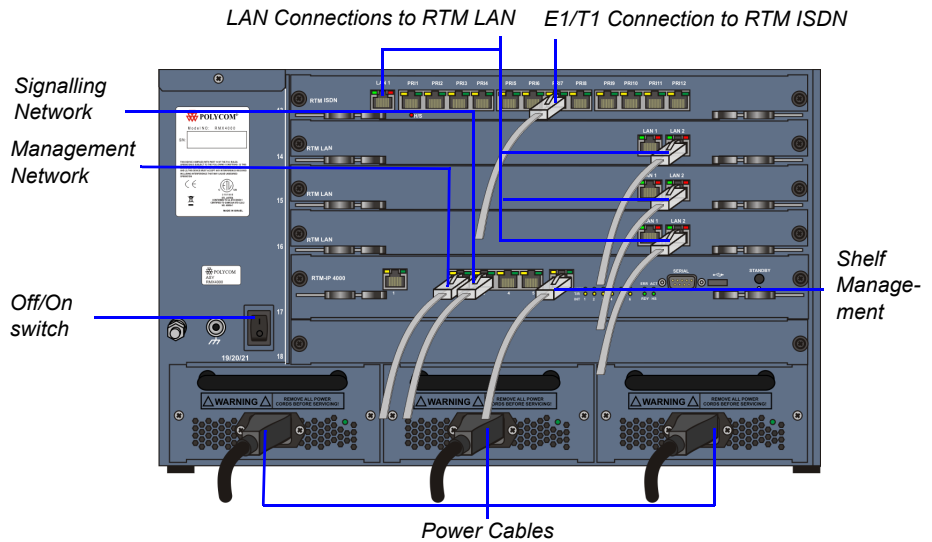
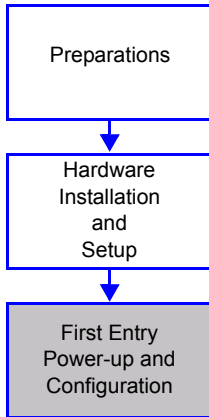

Figure 2-3 RMX 4000 Rear Panel View with AC Power and Communication Cables

First Entry Power-up and Configuration



There are four procedures necessary for setup of the new RMX. It is important that they are performed in the following sequence:

- 1 First-time Power-up
- 2 Product Registration.
- 3 Connection to MCU.
- 4 Modifying the Default IP and ISDN/PSTN Service Settings (*Fast Configuration Wizard*).

Procedure 1: First-time Power-up

To power-up for the first time using the USB key:

- 1 Insert the *USB key* containing the modified IP addresses in USB port on the RMX 1500 front panel and RMX 2000/4000 back panel.

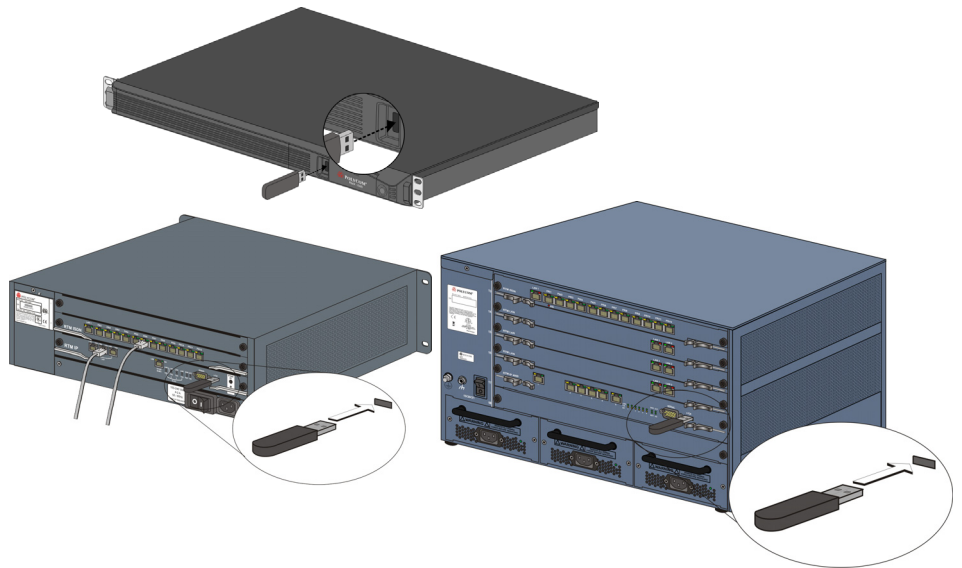

2 Power the RMX On.

AC System - Turn ON the power by pressing on the power switch located on the rear panel of the RMX 1500/2000/4000.

DC System (RMX 4000) - Turn ON the Main that supplies power to the RMX and then turn ON each of the DC power rail modules.

The parameters in the lan.cfg file are uploaded from the USB key to the RMX's memory and applied during the power-up sequence.

System power-up sequence may take up to five minutes.

During the First-time Power-up the red ERR LED on the RMX's front panel remains ON until both the *Management* and *IP Network Services* have been defined.

When the RMX's configuration is completed (including the *Management* and *IP Network Services*), and if there are no *System Errors*, the green RDY LED on the CNTL module (on the RMX's front panel) turns ON.

3 Remove the *USB key*.

Procedure 2: Product Registration

Before the RMX can be used, it is necessary to register the product and obtain an *Activation Key*.

During first-time power-up, the *Product Activation* dialog box is displayed, requesting you to enter an *Activation Key*.

Obtaining the Activation Key

- 1** Access the *Service & Support* page of the Polycom website at: <http://support.polycom.com>
- 2** Login with your *Email Address* and *Password* or register as a new user.
- 3** Select **Product Registration**.
- 4** Follow the on-screen instructions for *Product Registration* and *Product Activation*. (The RMX's serial number is on a sticker on the back of the unit, if needed.)
- 5** When the *Product Activation Key* is displayed, write it down or **copy** it for later pasting into the *Activation Key* field of the *Product Activation* dialog box.

Procedure 3: Connection to MCU



If Windows 7™ is installed on the workstation, **Protected Mode** must be disabled before connecting to the MCU running Version 6.0 software. For more information see "Windows 7™ Security Settings" on page 1-12.

- 1 Start the *RMX Web Client* application on the workstation.
 - a In the browser's address line, enter the IP address of the *Control Unit* in the format: **http://<Control Unit IP Address>**, as defined in the USB key.
 - b Press **Enter**.

The *RMX Web Client* Login screen is displayed.

- 2 In the *RMX Web Client* Login screen, enter the default *Username* (**POLYCOM**) and *Password* (**POLYCOM**) and click **Login**.

The *RMX Web Client* opens and the *Product Activation* dialog box appears with the serial number filled in:

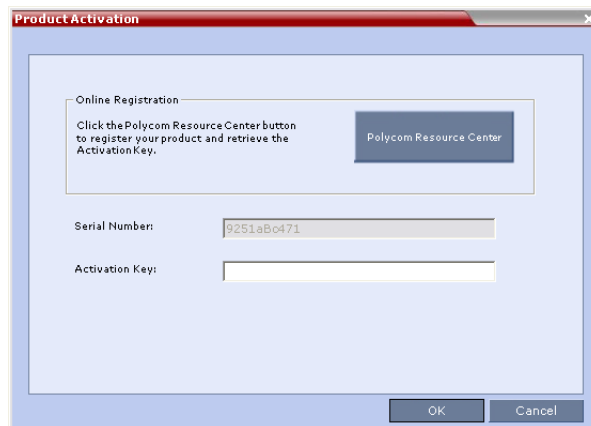

- 3 In the *Activation Key* field, enter or **paste** the *Product Activation Key* obtained earlier.
- 4 Click **OK**.

As no *Default IP Network Service* is defined, the system automatically starts the *Fast Configuration Wizard*.

Procedure 4: Modifying the Default IP Service and ISDN/PSTN Network Service Settings

The *Fast Configuration Wizard* assists in configuring the *Signaling Network Service*. It starts automatically if no *Signaling Network Service* is defined. This happens during *First Time Power-up*, before the service has been defined or if the *Signaling Service* has been deleted, followed by an RMX restart.

The *IP Management Service* tab in the *Fast Configuration Wizard* is enabled only if the factory default Management IP addresses were not modified.



On the *RMX 1500*, *RMX 2000* and *RMX 4000*, IPv4 is the default protocol for setting the Network Service in the *Fast Configuration Wizard*.

If IPv6 addressing is required, complete the *Fast Configuration Wizard* and then:

- 1** Modify the *Management Network* to use IPv6 addressing or IPv4 and IPv6 addressing.
- 2** Restart the RMX.
- 3** Use the *Fast Configuration Wizard* which will now include IPv6 addressing or IPv4 & IPv6 addressing options to configure the *Signaling Network Service*.

For detailed description of the IP Network Services, see the *RMX 1500/2000/4000 Administrator's Guide*.

Fast Configuration Wizard

- 1 Enter the required IP information in the dialog box.

RMX 1500

RMX 2000

RMX 4000

Table 2-3 *Fast Configuration Wizard – IP Signaling*

Field	Description
<i>Network Service Name</i>	The name <i>Default IP Service</i> is assigned to the IP Network Service by the Fast Configuration Wizard. This name can be changed. Note: This field is displayed in all IP Signaling dialog boxes and can contain character sets that use Unicode encoding.
<i>Signaling Host IP Address</i>	Enter the address to be used by IP endpoints when dialing in to the MCU. Dial out calls from the RMX are initiated from this address. This address is used to register the RMX with a Gatekeeper or a SIP Proxy server.
<i>Media Card 1-4 IP Addresses</i>	Enter the IP address(es) of the media card (s) (MPM/MPM+/MPMx 1 and MPM/MPM+/MPMx 2-4 (if installed)) as provided by the network administrator. Endpoints connect to conferences and transmit call media (video, voice and content) via these addresses.
<i>Subnet Mask</i>	Enter the subnet mask of the MCU. Default value: 255.255.255.0.



If *Secured Communication* is required on the RMX: complete the *Fast Configuration Wizard*, Login, install the *Certificate* and then enable *Secured Communication Mode*.

- 2 Click **Next**.

3 Enter the required **Routers** information in the dialog box.

The screenshot shows the 'Fast Configuration Wizard' window. On the left is a tree view with the following items: IP Management Service, IP Signaling, **Routers** (highlighted), DNS, Network Type, Gatekeeper, SIP Server, Security, ISDN/PSTN, PRI Settings, Span Definition, Phones, Spans, and System Flags. The main area on the right contains two input fields: 'Network Service Name' with the value 'Default IP Service' and 'Default Router IP Address' with the value '0.0.0.0'. At the bottom right are three buttons: 'Back', 'Next', and 'Cancel'.

Table 2-4 Fast Configuration Wizard – Routers

Field	Description
<i>Default Router IP Address</i>	Enter the IP address of the default router.

4 Click **Next**.

5 Enter the required DNS information in the dialog box.

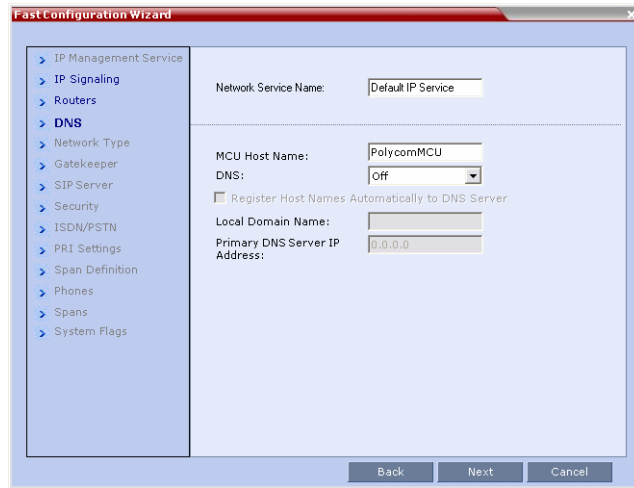

Table 2-5 Fast Configuration Wizard – DNS

Field	Description
<i>MCU Host Name</i>	Enter the name of the MCU on the network. Default name is RMX.
<i>DNS</i>	Select: <ul style="list-style-type: none"> • Off – if DNS servers are not used in the network. • Specify – to enter the IP addresses of the DNS servers. <p>Note: The IP address fields are enabled only if Specify is selected.</p>
<i>Register Host Names Automatically to DNS Server</i>	Select this option to automatically register the MCU Signaling Host and Shelf Management with the DNS server.
<i>Local Domain Name</i>	Enter the name of the domain where the MCU is installed.
<i>Primary DNS Server IP Address</i>	The static IP address of the primary DNS server.

- 6 Click **Next**.
- 7 Select the *IP Network Type*: **H.323, SIP** or **H.323 & SIP**.

Fast Configuration Wizard

- > IP Management Service
- > IP Signaling
- > Routers
- > DNS
- > **Network Type**
- > Gatekeeper
- > SIP Server
- > Security
- > ISDN/PSTN
- > PRI Settings
- > Span Definition
- > Phones
- > Spans
- > System Flags

Network Service Name:

IP Network Type:

Back Next Cancel

- 8 Click **Next**.
- 9 If you selected **SIP** only, go to **Step 13**.
- 10 Enter the required **Gatekeeper** information in the dialog box.

Fast Configuration Wizard

- > IP Management Service
- > IP Signaling
- > Routers
- > DNS
- > Network Type
- > **Gatekeeper**
- > SIP Server
- > Security
- > ISDN/PSTN
- > PRI Settings
- > Span Definition
- > Phones
- > Spans
- > System Flags

Network Service Name:

Gatekeeper:

Primary Gatekeeper

IP Address or Name:

MCU Prefix in Gatekeeper:

Aliases

Alias	Type
	None
	None
	None
	None
	None

Back Next Cancel

Table 2-6 Fast Configuration Wizard – Gatekeeper

Field	Description
<i>Gatekeeper</i>	Select Specify to enable configuration of the gatekeeper IP address. When Off is selected, all gatekeeper options are disabled.
Primary Gatekeeper	
<i>IP Address or Name</i>	Enter either the gatekeeper's host name (if a DNS Server is used) or IP address.
<i>MCU Prefix in Gatekeeper</i>	Enter the string with which the MCU registers itself with the gatekeeper. The gatekeeper uses this string to identify the MCU when forwarding calls to it. H.323 endpoints use this number as the first part of their dial-in string when dialing the MCU.
Aliases	
<i>Alias</i>	The alias that identifies the RMX's Signaling Host within the network. Up to five aliases can be defined for each RMX. Note: When a gatekeeper is specified, at least one prefix or alias must be entered in the table.
<i>Type</i>	The type defines the format in which the card's alias is sent to the gatekeeper. Each alias can be of a different type: <ul style="list-style-type: none"> • H.323 ID (alphanumeric ID) • E.164 (digits 0-9, * and #) • Email ID (email address format, e.g. abc@example.com) • Participant Number (digits 0-9, * and #) Note: Although all types are supported, the type of alias to be used depends on the gatekeeper's capabilities.

11 Click **Next**.

12 If you selected **H.323** only, go to **Step 15**.

13 Enter the required **SIP Server** information in the dialog box.

The screenshot shows the 'Fast Configuration Wizard' window. On the left is a tree view with 'SIP Server' selected. The main area contains the following fields:

- Network Service Name: Default IP Service
- SIP Server: Off (dropdown menu)
- Server IP Address or Name: 0.0.0.0
- Server Domain Name: DomainName
- Transport Type: TCP (dropdown menu)

At the bottom are buttons for 'Back', 'Save & Conti', and 'Cancel'.

Table 2-7 Fast Configuration Wizard – SIP Server

Field	Description
<i>SIP Server</i>	Select: <ul style="list-style-type: none"> Specify – to manually configure SIP servers. Off – if SIP servers are not present in the network.
<i>SIP Server IP Address</i>	Enter either the IP address of the preferred SIP server or its host name (if a DNS server is used).
<i>Transport Type</i>	Select the protocol that is used for signaling between the MCU and the SIP Server or the endpoints according to the protocol supported by the SIP Server: <p>UDP – Select this option to use UDP for signaling. TCP – Select this option to use TCP for signaling. TLS – The <i>Signaling Host</i> listens on secured port 5061 only and all outgoing connections are established on secured connections. Calls from SIP clients or servers to non secured ports are rejected.</p>

Table 2-7 Fast Configuration Wizard – SIP Server (Continued)

Field	Description
<i>Transport Type (cont.)</i>	The following protocols are supported: <ul style="list-style-type: none"> • TLS 1.0 • SSL 2.0 • SSL 3.0.

14 Click **Next**.

Enter the required **Security** information in the dialog box.

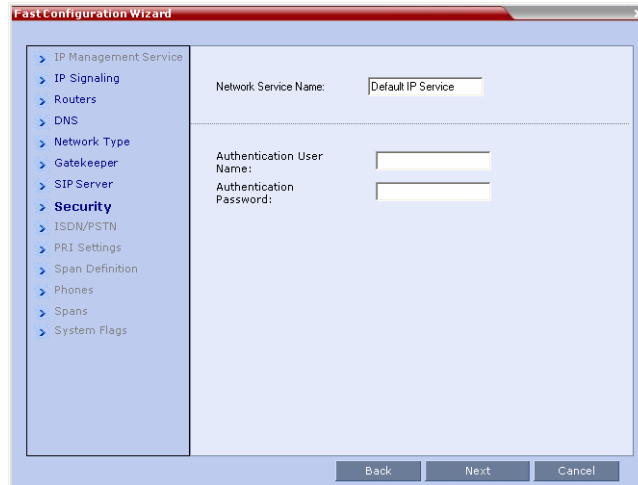

Table 2-8 Fast Configuration Wizard – Security

Field	Description
<i>Authentication User Name</i>	Enter the conference, Entry Queue or Meeting Room name as registered with the proxy. This field can contain up to 20 ASCII characters.
<i>Authentication Password</i>	Enter the conference, Entry Queue or Meeting Room password as defined in the proxy. This field can contain up to 20 ASCII characters.

15 Click **Next**.

The IP Network Service is created and confirmed.



16 Click **OK**.

During the initial *RMX* setup, if the system detects the presence of the *RTM ISDN* card, the *ISDN/PSTN Network Service* definition screens of the *Fast Configuration Wizard* are enabled.

If there is no *RTM ISDN* card in the *RMX* or if you do not want to define an *ISDN/PSTN Network Service*, go to Step 33..



A new *ISDN/PSTN Network Service* can be defined even if no *RTM ISDN* card is installed in the system **but** only via the *ISDN/PSTN Network Service ->Add New Service* dialog box.

The *Fast Configuration Wizard's* *ISDN/PSTN* configuration sequence begins with the *ISDN/PSTN* dialog box:

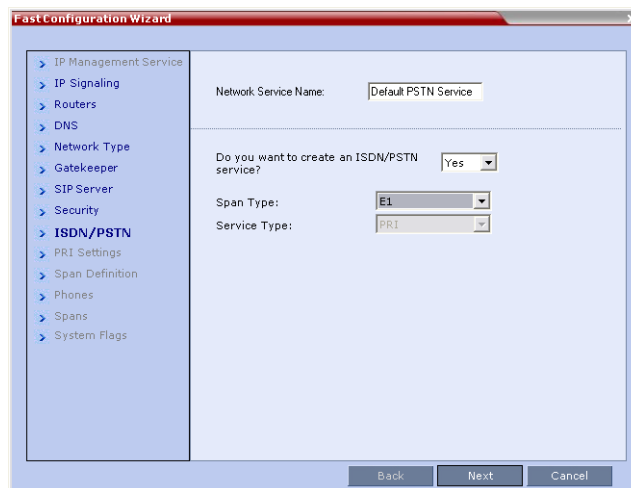

17 Define the following parameters:**Table 2-9** *Fast Configuration Wizard – ISDN Service Settings*

Field	Description
<i>Network Service Name</i>	<p>Specify the service provider's (carrier) name or any other name you choose, using up to 20 characters. The Network Service Name identifies the ISDN/PSTN Service to the system.</p> <p>Default name: ISDN/PSTN Service</p> <p>Note: This field is displayed in all ISDN/PSTN Network Properties tabs and can contain character sets that use Unicode encoding.</p>
<i>Span Type</i>	<p>Select the type of spans (ISDN/PSTN) lines, supplied by the service provider, that are connected to the RMX. Each span can be defined as a separate Network Service, or all the spans from the same carrier can be defined as part of the same Network Service.</p> <p>Select either:</p> <ul style="list-style-type: none"> • T1 (U.S. – 23 B channels + 1 D channel) • E1 (Europe – 30 B channels + 1 D channel) <p>Default: T1</p> <p>Note: Only one <i>Span Type</i> (E1 or T1) is supported on the RMX. If you define the first span as type E1 all other spans that you may later define must also be of type E1.</p>
<i>Service Type</i>	<p>PRI is the only supported service type. It is automatically selected.</p>

18 Click Next.

The *PRI Settings* dialog box opens.

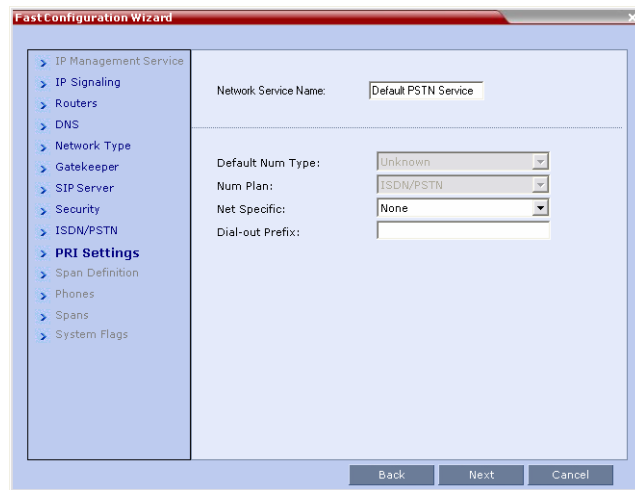

19 Define the following parameters:

Table 2-10 *Fast Configuration Wizard – PRI Settings*

Field	Description
<i>Default Num Type</i>	<p>Select the Default Num Type from the list.</p> <p>The Num Type defines how the system handles the dialing digits. For example, if you type eight dialing digits, the Num Type defines whether this number is national or international.</p> <p>If the PRI lines are connected to the RMX via a network switch, the selection of the Num Type is used to route the call to a specific PRI line. If you want the network to interpret the dialing digits for routing the call, select Unknown.</p> <p>Default: Unknown</p> <p>Note: For E1 spans, this parameter is set by the system.</p>

Table 2-10 Fast Configuration Wizard – PRI Settings (Continued)

Field	Description
<i>Num Plan</i>	Select the type of signaling (Number Plan) from the list according to information given by the service provider. Default: ISDN Note: For E1 spans, this parameter is set by the system.
<i>Net Specific</i>	Select the appropriate service program if one is used by your service provider (carrier). Some service providers may have several service programs that can be used. Default: None
<i>Dial-out Prefix</i>	Enter the prefix that the PBX requires to dial out. Leave this field blank if a dial-out prefix is not required. The field can contain be empty (blank) or a numeric value between 0 and 9999 . Default: Blank

20 Click **Next**.

The *Span Definition* dialog box opens.

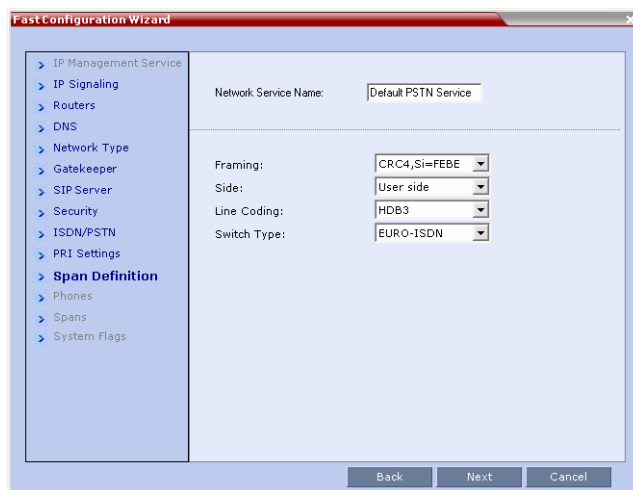

21 Define the following parameters:**Table 2-11** *Fast Configuration Wizard – Spans Definition*

Field	Description
<i>Framing</i>	Select the Framing format used by the carrier for the network interface from the list. <ul style="list-style-type: none"> For T1 spans, default is SFISF. For E1 spans, default is FEFE.
<i>Side</i>	Select one of the following options: <ul style="list-style-type: none"> User side (default) Network side Symmetric side <p>Note: If the PBX is configured on the network side, then the RMX unit must be configured as the user side, and vice versa, or both must be configured symmetrically.</p>
<i>Line Coding</i>	Select the PRI line coding method from the list. <ul style="list-style-type: none"> For T1 spans, default is B8ZS. For E1 spans, default is HDB3.
<i>Switch Type</i>	Select the brand and revision level of switch equipment installed in the service provider's central office. <ul style="list-style-type: none"> For T1 spans, default is AT&T 4ESS. For E1 spans, default is EURO ISDN.

22 Click **Next**.

The *Phones* dialog box opens.

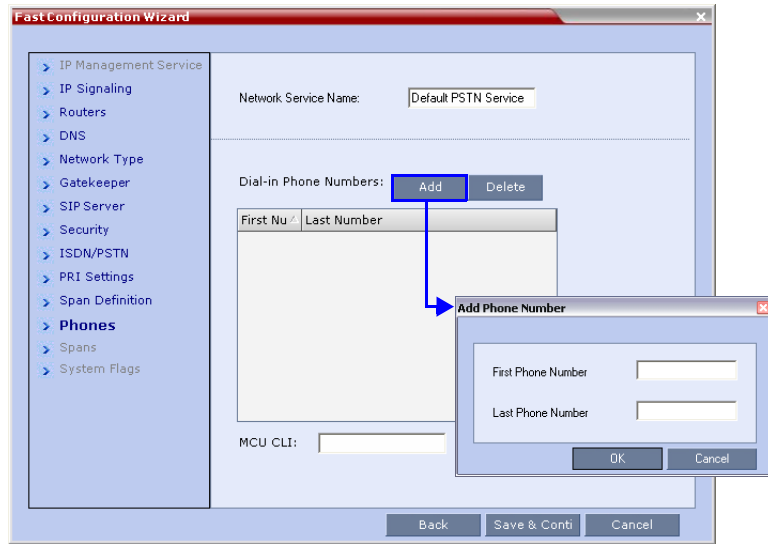

23 Click **Add** to define dial-in number ranges.

The *Add Phone Number* dialog box opens.

24 Define the following parameters:

Table 2-12 Fast Configuration Wizard – Add Phone Numbers

Field	Description
<i>First Number</i>	The first number in the phone number range.
<i>Last Number</i>	The last number in the phone number range.



- A range must include at least two dial-in numbers.
- A range cannot exceed 1000 numbers.

25 Click **OK**.

The new range is added to the *Dial-in Phone Numbers* table.

26 **Optional.** Repeat steps **23** to **24** to define additional dial-in ranges.

27 In the *Phones* tab enter the *MCU CLI* (Calling Line Identification).

With dial-in connections, the *MCU CLI* indicates the MCU's number dialed by the participant. In a dial-out connection, indicates the MCU (CLI) number as seen by the participant.

28 Click **Save & Continue**.

After clicking **Save & Continue**, you cannot use the **Back** button to return to previous configuration dialog boxes.

The *ISDN/PSTN Network Service* is created and is added to the ISDN/PSTN Network Services list.

If the system cannot create the *ISDN/PSTN Network Service*, an error message is displayed indicating the cause and allowing you access the appropriate dialog box in the *Fast Configuration Wizard* for corrective action.



29 Click **OK** to continue the configuration.

The *Spans* dialog box opens displaying the following read-only fields:

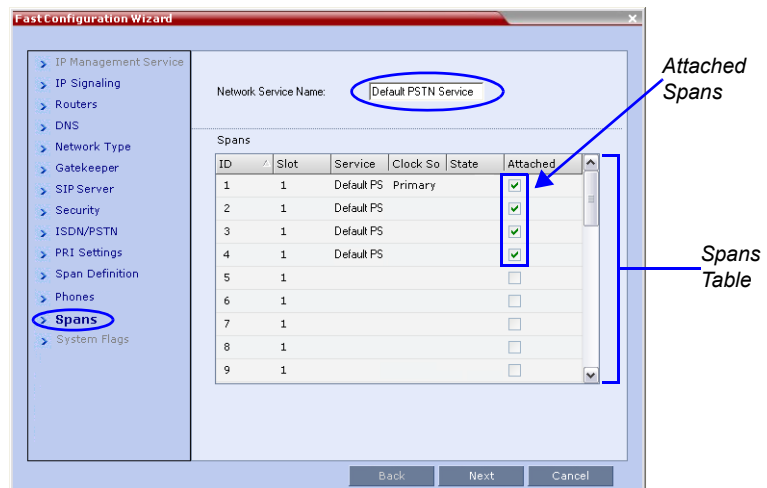

— *ID* - the connector on the *RTM ISDN* card (*PRI1* to *PRI12*).

- **Slot** – the *MPM/MPM+/MPMx* card that the *RTM ISDN / RTM ISDN 1500* card is connected to (RMX 2000: *MPM 1/MPM2* RMX 4000: *MPM1/MPM2/MPM3/MPM4*).



On the RMX 1500, the *Slot* field does not appear.

- **Service** – the *ISDN/PSTN Network Service* to which the span is assigned.
- **Clock Source** – indicates if *ISDN* signaling synchronization is being supplied by the *Primary* or *Secondary* clock source. The first span to synchronize becomes the *Primary* clock source.
- **State** – the *System Alert* level of the span (*Major, Minor*). If there are no span related alerts, this column contains no entries.

- 30** Click the check boxes in the *Attached* field to attach spans (E1 or T1 PRI lines) to the network service named in the *Network Service Name* field.

The *Spans Table* displays the configuration of all spans and all *ISDN* network services in the system.

When using the *Fast Configuration Wizard* during *First Entry Configuration*, you are defining the first *ISDN/PSTN Network Service* in the system. Spans can only be attached to this service.

Additional *ISDN/PSTN Network Services* can be defined by using the **ISDN/PSTN Network Services > New PSTN Service** button in the *RMX Web Client*.

Spans can be attached to, or moved between *ISDN* network services by using the **ISDN/PSTN Network Services > ISDN Properties > Spans** tab in the *RMX Web Client*.

Each *ISDN* RTM card can support either 7 E1 or 9 T1 PRI lines (E1 and T1 connections cannot be used simultaneously).

- 31** Click **Next**.

The *System Flags* dialog box is displayed.

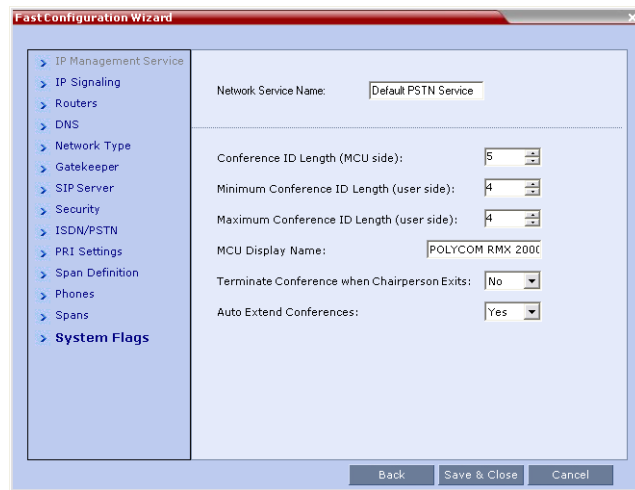

32 Enter the required **System Flags** information in the dialog box.

Table 2-13 Fast Configuration Wizard – System Flags

Field	Description / Default	
<i>Conference ID Length (MCU)</i>	The number of digits of the Conference ID to be assigned by the MCU. Range: 2-16 (Default: 5)	Note: Selecting 2 digits limits the number of simultaneous ongoing conferences to 99.
<i>Minimum Conference ID Length (User)</i>	The minimum number of digits that the user must enter when manually assigning a numeric ID to a conference. Range: 2-16 (Default: 4)	
<i>Maximum Conference ID Length (User)</i>	The maximum number of digits that the user can enter when manually assigning a Numeric ID to a conference. Range: 2-16 (Default: 8)	
<i>MCU Display Name</i>	The MCU name is displayed on the endpoint's screen. Default name: <i>Polycom RMX 1500/2000/4000</i>	

Table 2-13 Fast Configuration Wizard – System Flags (Continued)

Field	Description / Default
<i>Terminate Conference when Chairperson Exits</i>	When Yes is selected (default), the conference ends when the chairperson exits even if there are other participants connected. When No is selected, the conference automatically ends at the predefined end time, or when all the participants have disconnected from the conference.
<i>Auto Extend Conferences</i>	When Yes is selected (default), allows conferences running on the RMX to be automatically extended as long as there are participants connected and there are available resources. The maximum extension time allowed by the MCU is 30 minutes.

These flags can be modified later, if required, by selecting the *System Configuration* option from the *Setup* menu. For more information, see the *RMX 1500/2000/4000 Administrator's Guide, "System Configuration"* on page 18-5.

- 33** Click **Save & Close**.
- The RMX confirms successful configuration.
- 34** In the *Success Message* box, click **OK**.
- 35** In the *Reset Confirmation* dialog box, click **Yes**.

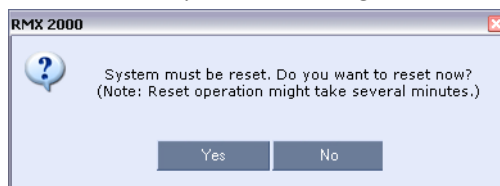

- 36** In the *Please wait for system reset* message box, click **OK**.



System restart may take up to five minutes.

- 37** Refresh the browser periodically until the *Login* screen is displayed.
- 38** When the *Login* screen is displayed, enter your *Username* and *Password* and click **Login**.

On first entry, the default *Username* and *Password* are both **POLYCOM**. In the *RMX Web Client's Main Screen* an *MCU State* indicator displays a progress indicator **Starting up (15:25)** showing the time remaining until the system start-up is complete.

- 39** Create a new *User* with *Administrator* permissions and delete the default *User* (**POLYCOM**).

For system security reasons the system is not fully configured until this step has been performed.

For more information see the *RMX 1500/2000/4000 Administrator's Guide, "Users, Connections and Notes"* on page **12-1**.

- 40** The system is now fully configured and if there are no *System Errors*, the green *RDY* LED on the *CNTL* module (on the *RMX's* front panel) turns ON.



The *Fast Configuration Wizard* configures the *Default IP Network Service* with common parameters. Specific or additional settings (e.g. for *ICE*, or *Secured Mode*) should be performed once the initial configuration is complete. For detailed description of the *IP Network Services*, see the *RMX 1500/2000/4000 Administrator's Guide*.

User Definition

The *RMX* is shipped with a default *Administrator* user called **POLYCOM**. Once you have defined other authorized administrator users, it is recommended to remove the default user to prevent unauthorized users from logging into the system.

For more information, see the *RMX 1500/2000/4000 Administrator's Guide "Deleting a User"* on page **12-4**.

Selecting the RMX Web Client Languages

By default, the *RMX Web Client* interface is displayed only in English. However, the system administrator can choose the languages available for selection on the *Login* screen. These languages are represented by flags.

To choose the languages for selection in the *Login* screen:

- 1 On the *RMX* menu, click **Setup > Multilingual Setting**.

- 2 Click the check boxes of the languages to appear in the Login screen of the *RMX Web Client*. For more information see the *RMX 1500/2000/4000 Administrator's Guide "Multilingual Setting"* on page **18-88**.

If the selected language is not supported by the browser or the workstation's Operating System, the *RMX Web Client* is displayed in English.

- 3 Click **OK**.
- 4 Log out and reconnect to the RMX.
The Login screen will display the flags of the selected languages.

RMX's Default Conferencing Settings

The RMX is shipped with default pre-configured conferencing entities, which allow RMX users and participants to start ongoing conferences without further configuration.

The default conferencing entities are:

Table 2-14 Conferencing Entities

Entity	Description										
<i>Meeting Rooms</i>	<p>Conferences saved on the MCU without using resources. They are activated when the first participant dials in. There are four Meeting Rooms ready for use:</p> <table> <thead> <tr> <th>Name</th> <th>ID</th> </tr> </thead> <tbody> <tr> <td><i>Maple_Room</i></td> <td><i>1001</i></td> </tr> <tr> <td><i>Oak_Room</i></td> <td><i>1002</i></td> </tr> <tr> <td><i>Juniper_Room</i></td> <td><i>1003</i></td> </tr> <tr> <td><i>Fig_Room</i></td> <td><i>1004</i></td> </tr> </tbody> </table> <p>Each Meeting Room uses the default <i>Conference Profile</i> called <i>Factory Video Profile</i> running at 384Kbps and has a default duration of one hour.</p>	Name	ID	<i>Maple_Room</i>	<i>1001</i>	<i>Oak_Room</i>	<i>1002</i>	<i>Juniper_Room</i>	<i>1003</i>	<i>Fig_Room</i>	<i>1004</i>
Name	ID										
<i>Maple_Room</i>	<i>1001</i>										
<i>Oak_Room</i>	<i>1002</i>										
<i>Juniper_Room</i>	<i>1003</i>										
<i>Fig_Room</i>	<i>1004</i>										

Table 2-14 Conferencing Entities (Continued)

Entity	Description
<i>Conference Profile</i>	<p>Name: <i>Factory Video Profile</i></p> <p>A Conference Profile is assigned to a Meeting Room to define its conferencing parameters, such as line rate and video resolution.</p> <p><i>Factory Video Profile</i> contains the video conference parameters with a bit rate of 384Kbps, <i>Auto Layout</i> and <i>Polycom Skin</i>. The Profile uses an IVR Service called <i>Conference IVR Service</i>.</p>
<i>Conference IVR Service</i>	<p>Name: <i>Conference IVR Service</i></p> <p>The <i>Conference IVR Service</i> includes an optional video slide and all the voice messages played during the participant's connection process and during the conference.</p> <p>The <i>Conference IVR Service</i> contains a set of voice prompts in English and an optional video slide. It automates the participant's connection to a conference.</p>

Table 2-14 Conferencing Entities (Continued)

Entity	Description				
<p><i>Entry Queue</i></p>	<table border="0"> <tr> <td style="vertical-align: top;">Name</td> <td style="vertical-align: top;">ID</td> </tr> <tr> <td><i>DefaultEQ</i></td> <td>1000</td> </tr> </table> <p>Using an Entry Queue enables one dial-in number to be used for all conferences. In the Entry Queue, participants are prompted for information to enable routing to their destination conferences.</p> <p>A default Entry Queue called <i>DefaultEQ</i> is provided. The default Entry Queue is also set to Ad Hoc conferencing which allows participants to start new conferences without prior definition by entering a Conference or Meeting Room ID that is not used by any on going conference currently running on the MCU. It uses an Entry Queue IVR Service called <i>Entry Queue IVR Service</i>.</p> <p>The default <i>Welcome Slide</i> displayed at the participants endpoint upon connection to the Entry Queue and lists the default Meeting Rooms. The participant can select one of these Meeting Rooms or enter another ID to start a new conference.</p> <p>If no <i>Transit Entry Queue</i> is defined, <i>DefaultEQ</i> is the default <i>Transit Entry Queue</i>. For more information see the <i>RMX 1500/2000/4000 Administrator's Guide</i>, "Transit Entry Queue" on page 4-9.</p> <p>Note: An ISDN/PSTN dial-in number is not assigned to the <i>Entry Queue</i> as the number depends on the dial-in numbers range defined in the <i>Network Service</i>. It must be manually assigned to enable ISDN or PSTN participant connections to this <i>Entry Queue</i>. For more information, see the <i>RMX 1500/2000/4000 Administrator's Guide</i>, "ISDN/PSTN Network Services" on page 13-50.</p>	Name	ID	<i>DefaultEQ</i>	1000
Name	ID				
<i>DefaultEQ</i>	1000				
<p><i>Entry Queue IVR Service</i></p>	<p>Name: <i>Entry Queue IVR Service</i></p> <p>Includes all the voice messages and video slides used to guide participants through their connection process to the MCU and route them to their destination conference.</p> <p><i>Entry Queue IVR Service</i> is the default Entry Queue IVR Service provided for the default Entry Queue.</p>				

Customizing the RMX's Default Conferencing Settings

You can customize the conferencing entities to your organization's requirements:

- **To customize the Voice Prompts and Video Slides** to different organizations, users, languages etc. – first record the required messages and create the video slides and then create the appropriate conference IVR Service or Entry Queue IVR Service. These services must be assigned to the appropriate conference profile or Entry Queue. For more information, see the *RMX 1500/2000/4000 Administrator's Guide, "IVR Services"* on page **14-1**.
- **To modify the conference properties**, such as the conference line rate, specific video layout for the conference or the background that is used for the video display (skin), create a new Conference Profile. This Profile can be used for defining new ongoing conferences, Meeting Rooms and Single-dial Entry Queues. For more information, see the *RMX 1500/2000/4000 Administrator's Guide, "Defining Profiles"* on page **1-9**.
- **To allow ISDN participants to connect to a single dial Entry Queue** a dial in number must be assigned to the pre-configured Entry Queue.
To allow participants to connect to a single dial Entry Queue at a line rate other than 384 Kbps (as in the default Entry Queue) or play voice messages in different languages – create a new Entry Queue. For more information, see the *RMX 1500/2000/4000 Administrator's Guide, "Defining a New Entry Queue IVR Service"* on page **14-29**.
- **You can personalize Meeting Rooms** for people in your organization with predefined conference and chairperson passwords (for added security) and allow only authorized people to start on going conferences. For more information, see the *RMX 1500/2000/4000 Administrator's Guide, "Meeting Rooms"* on page **3-1**.
- **To allow ISDN participants to connect directly to Meeting Rooms** a dial in number must be assigned to the pre-configured Meeting Room.
- The conferencing entities are designed mainly for dial in participants without prior definition of participants. **You can create your own Address Book** containing a list of participants to be dialed by the MCU. Once defined, these participants can be added to ongoing conferences saving the need to define them again.

For more information, see the *RMX 1500/2000/4000 Administrator's Guide, "Address Book"* on page **5-1**.

- You can schedule conferences to start in the future.

Basic Operation

The most common operations performed via the *RMX Web Client* are:

- Starting, monitoring and managing conferences
- Monitoring and managing **participants** and **endpoints** as individuals or **groups**.
 - **Participant** – A person using an endpoint to connect to a conference. When using a *Room System*, several participants use a single endpoint.
 - **Endpoint** – A hardware device, or set of devices, that can call, and be called by an MCU or another endpoint. For example, an endpoint can be a phone, a camera and microphone connected to a PC or an integrated *Room System* (conferencing system).
 - **Group** – A group of participants or endpoints with a common name.

Starting the RMX Web Client

Before you begin you need to get the following information from your system administrator:

- User name
- Password
- MCU Control Unit IP Address

To start the RMX 2000 Web Client:

- 1 In your browser address line, enter **http://<Control Unit IP Address>** and press the **Enter** key.

The *Login* screen is displayed.

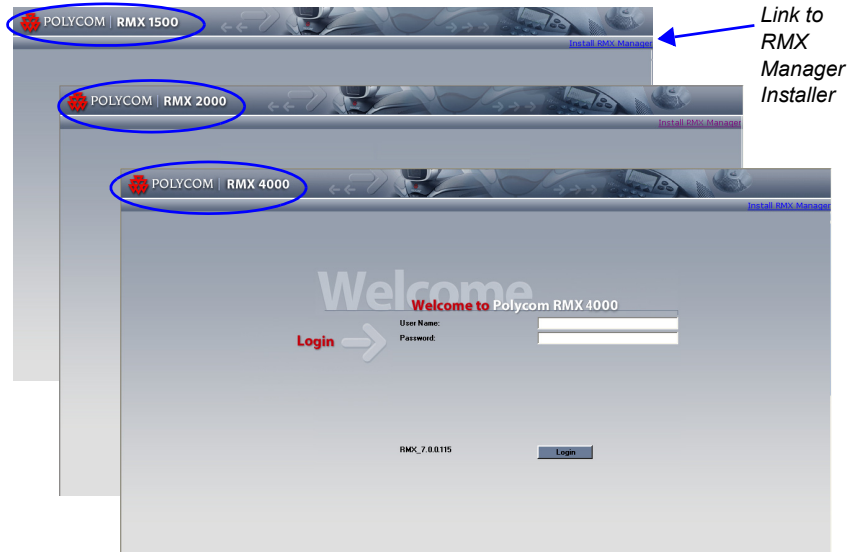

- 2 Enter your *Username* and *Password* and click the **Login** button.
On first entry, the default *Username* and *Password* are both **POLYCOM**.
The *RMX 2000 Web Client* main screen is displayed.



The Login screen contains a link to the *RMX Manager* installer. Using the *RMX Manager* application, a single user can control a single or multiple RMX units as well as conferences from multiple RMXs. RMX 1500/2000/4000 can be managed and controlled by the *RMX Manager* application. For more information see the *RMX 1500/2000/4000 Administrator's Guide*, "*RMX Manager Application*" on page **17-1**.

RMX 2000 Web Client Screen Components

The *RMX 2000 Web Client's* main screen consists of five panes:

- *Conference List*
- *List Pane*
- *RMX Management*
- *Status Bar*
- *Address Book*
- *Conference Templates*

You can login as a user with *Chairperson*, *Operator* or *Administrator* authorization. Your *Authorization Level* determines your viewing and system functions.

For more information see the *RMX 1500/2000/4000 Administrator's Guide*, "*Users, Connections and Notes*" on page **12-1**.

The *Administrator's* view is shown below:

The screenshot shows the RMX 2000 Web Client interface. The main window is titled "POLYCOM | RMX 2000" and contains several panes. On the left, there is a navigation menu with "RMX Management" selected. The central pane displays a "Participants (4)" table. On the right, there is an "Address Book (997)" pane. At the bottom, there is a "Status Bar" showing system alerts and port usage.

Labels on the left side of the screenshot point to the following components:

- Conferences List**: Points to the "Conferences (2)" pane at the top left.
- List**: Points to the "Participants (4)" table in the center.
- RMX Management**: Points to the "RMX Management" pane on the left side.
- Address Book**: Points to the "Address Book (997)" pane on the right side.
- Conference Templates Tab**: Points to the "Conference Templates (0)" pane on the far right.
- Status Bar**: Points to the bottom status bar.

Display Name	Status	ID	Start Time	Name	Status	Role	IP Address	Alias Name	Network	Dialing Device	Audio	Video
SUPP		43020	12:23 P	SUPPORT_1061057406	Conn							
conf_	Single	04338	2:59 PM	isd1	Conn		124578		ISDN/PS	Dial o		
				isd1	Conn		78789		ISDN/PS	Dial o		
				Faran	Conn		172.22.		H.323	Dial o		
				ISDN	Conn		1234		ISDN/PS	Dial o		

The main screen can be customized. For more information, see "*Customizing the Main Screen*" on page **3-11**.

Viewing and System Functionality Permissions

The RMX 2000 Web Client user's viewing and system functionality depend on the authorization level assigned to each user as summarized in Table 3-1:

Table 3-1 Viewing and System Permissions

	Authorization Level		
	Chairperson	Operator	Administrator
	Viewing Permissions		
Conference List	✓	✓	✓
List Pane	✓	✓	✓
Address Book	✓	✓	✓
Conference Templates		✓	✓
Status Bar		✓	✓
RMX Management		✓	✓
Conference Alarms		✓	✓
Conference Status		✓	✓
Configurations		✓	✓
	System Functionality		
Start Conferences	✓	✓	✓
Monitor Conferences	✓	✓	✓
Monitor Participants	✓	✓	✓
Solve Basic Problems		✓	✓
Modify MCU Configuration			✓



In addition to Chairpersons, Operators and Administrators, an Auditor is a user type that can view Auditor Files and audit the system. For more information see the RMX 1500/2000/4000 Administrator's Guide "Auditor" on page [18-103](#).

Conferences List

If you are logged in as a user with *Operator* or *Administrator* permissions:

The *Conferences* pane lists all the conferences currently running on the MCU along with their *Status*, *Conference ID*, *Start Time* and *End Time* data. The number of ongoing conferences is displayed in the pane's title.

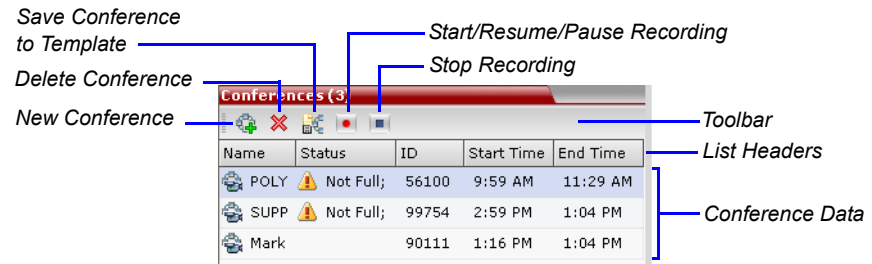

The *Conferences* list toolbar contains the following buttons:

- **New Conference** – to start a new ongoing conference.
- **Delete Conference** – delete the selected conference(s).

If *Conference Recording* is enabled the following are displayed in color:

- **Start/Resume Recording** – start/resume recording.
- **Stop Recording** – stop recording.
- **Pause** – toggles with the *Start/Resume* button.

If you are logged in as a user with *Chairperson* permissions:

- You can list and monitor conferences you have started or for which you have entered the password or that don't have a *Chairperson Password* assigned.
- A *Chairperson Password* field and a **Refresh** button are displayed. The **Refresh** button does not change the *Chairperson Password*; it refreshes the *Conferences* list to display all ongoing conferences with the requested password.

For more information see “Using the *Chairperson Password* for Filtering” on page 3-49.

- A *Chairperson Password* column is included in the conference data.

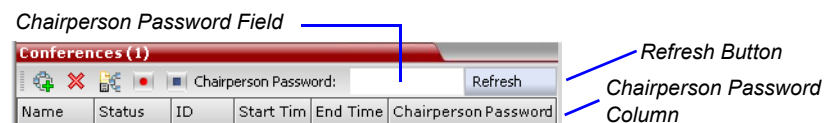

List Pane

The *List* pane displays details of the item selected in the *Conferences* pane or *RMX Management* pane. The title of the pane changes according to the selected item.

When selecting an ongoing conference in the *Conferences* pane, it displays the list and parameters of the connected participants.



When selecting an item in the *Device Management* pane, lists the items currently defined for that item. For example, if *Users* is selected, it displays the list of RMX Users defined for the selected RMX.

RMX Management

Viewing Permissions		
Chairperson	Operator	Administrator
	✓	✓

The *RMX Management* pane lists the entities that need to be configured to enable the RMX to run conferences. Only users with Administrators permission can modify these parameters.

The *RMX Management* pane is divided into two sections:

- **Frequently Used** – parameters often configured monitored or modified.
- **Rarely Used** – parameters configured during initial system set-up and rarely modified afterward.

Items can be moved between these two sections to customize the management tasks per RMX User. For more details, see "*Customizing the RMX Management Pane*" on page [3-12](#).

Status Bar

The Status Bar at the bottom of the RMX Web Client contains *System* and *Participant Alerts* tabs as well as *Port Usage Gauges* and an *MCU State* indicator.



Viewing Permissions		
Chairperson		
	Operator	
		Administrator
	✓	✓

System Alerts

This is a list of system problems. The alert indicator flashes red when at least one system alert is active. The flashing continues until a user with Operator or Administrator permission reviews the list.

The *System Alerts* pane is opened and closed by clicking the **System Alerts** button in the left corner of the *Status Bar*.

Active

Alarms

Faults

List

Time	Category	Level	Code	Process Name	Description
9/25/2006	general	major	IP_SERVICE_CHANGED	CSMngr	ip service was changed, reset the RMX (Task status: Normal)
9/13/2006	card	major	NO_CONNECTION_WITH_CARD	Cards	Board ID:0, Card Type:switch, Description: No connection with Switch (Task status: Normal)
9/13/2006	general	major	INTERNAL_MCU_RESET	McmsDaemo	No connection with Switch (Task status: Normal)
9/13/2006	general	major	INSUFFICIENT_RESOURCES	Resource	Insufficient resources (Task status: Normal)
9/13/2006	card	major	CARD_STARTUP_FAILURE	Cards	Board ID:0, Card Type:illegal, Description: MFA start failure (Task status: Normal)
9/13/2006	general	major	CFG_CHANGED	McuMngr	SYSTEM CFG was changed, reset the RMX (Task status: Normal)

For more information about **Active Alarms** and **Faults List**, see the *RMX 1500/2000/4000 Administrator's Guide, "System and Participant Alerts"* on page 18-1.

Viewing Permissions		
Chairperson		
	Operator	
		Administrator
✓	✓	✓

Participant Alerts

This is a list of participants that are experiencing connection problems. It is sorted by conference.

The *Participant Alerts* pane is opened and closed by clicking the **Participant Alerts** button in the left corner of the *Status Bar*.

Conference	Name	Status	Disconnection Time	Role	IP Address	Alias	Network	Dialing Direction	Audio	Video	Encryption	FECC Tol
Marketing	V69	discon	9/21/2006 2:18 PM		172.22.189		H.323	Dial out				
Marketing	V96	discon	9/21/2006 2:18 PM		172.22.186		H.323	Dial out				

Viewing Permissions		
Chairperson		
	Operator	
		Administrator
	✓	✓

Port Usage Gauges

The *Port Usage* gauges indicate:

- The total number of *Video* or *Voice* ports in the system according to the *Video/Voice Port Configuration*.
- The number of *Video* and *Voice* ports in use.

- The *High Port Usage* threshold.

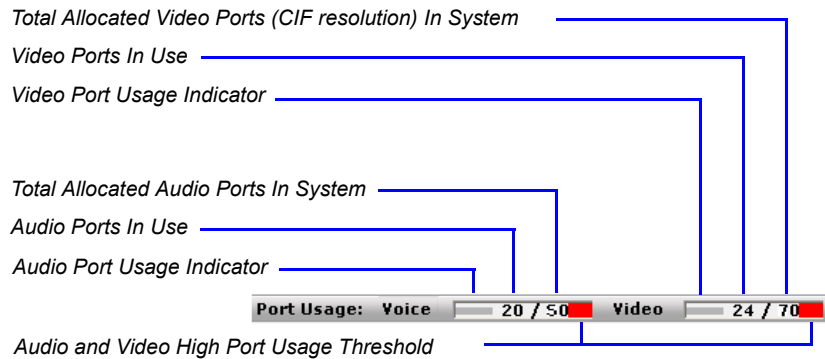

The High Port Usage threshold represents a percentage of the total number of video or voice ports available. It is set to indicate when resource usage is approaching its maximum, resulting in no free resources to run additional conferences. When port usage reaches or exceeds the threshold, the red area of the gauge flashes and a *System Alert* is generated. The default port usage threshold is 80% and it can be modified by the system administrator. For more information, see the *RMX 1500/2000/4000 Administrator's Guide*, "Port Usage" on page 18-64.

Viewing Permissions		
Chairperson	Operator	Administrator
✓	✓	✓

MCU State

The *MCU State* indicator displays one of the following:

- **Starting up (15:25)** – The MCU is starting up. The time remaining until the system start-up is complete is displayed between brackets while a green progress indicator bar indicates the start-up progress.

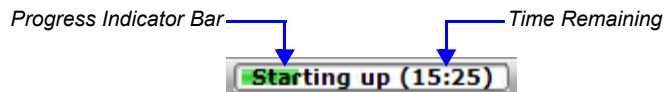

- **MCU State: NORMAL** – The MCU is functioning normally.
- **MCU State: MAJOR** – The MCU has a major problem. MCU behavior could be affected and attention is required.

Address Book

Viewing Permissions		
Chairperson	Operator	Administrator
✓	✓	✓

The *Address Book* is a list of *Participants* and *Groups* that have been defined on the RMX. The information in the *Address Book* can be modified only by an administrator. All RMX users can, however, view and use the *Address Book* to assign participants to conferences.

The *Address Book* toolbar contains a *Quick Search* field and the following six buttons:

- *New Participant*
- *Delete Participant*
- *Import Address Book*
- *New Group*
- *Delete Group*
- *Export Address Book*

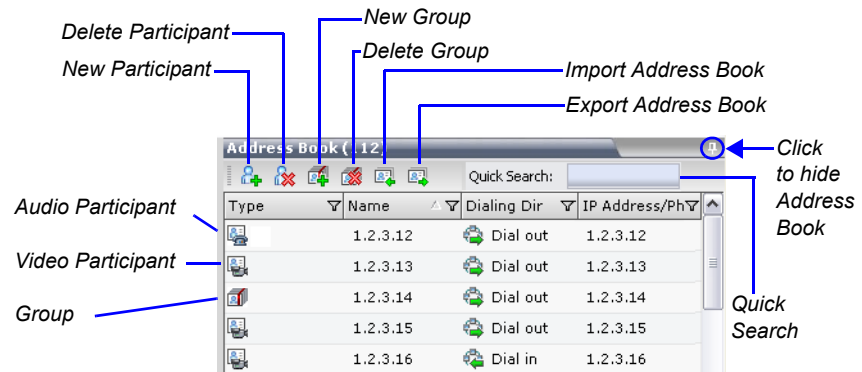

Address Book entries are listed according to:

- **Type** - whether an individual *Participant* or a *Group* of participants
- **Name** - of the participant or group
- **Dialing Direction** - Dial-in or Dial-out
- **IP Address/Phone** - of the participant

Displaying and Hiding the Address Book

The first time you access the *RMX Web Client*, the *Address Book* pane is displayed. You can hide it by clicking the anchor pin (📌) button.

The *Address Book* pane closes and a tab appears at the right edge of the screen.

Click the tab to re-open the *Address Book*.

Click tab to open Address Book



Conference Templates

Conference Templates enable administrators and operators to create, save, schedule and activate identical conferences.

A *Conference Template*:

- Saves the conference Profile.
- Saves all participant parameters including their *Personal Layout* and *Video Forcing* settings.
- Simplifies the setting up *Telepresence* conferences where precise participant layout and video forcing settings are crucial.

Displaying and Hiding Conference Templates

The *Conference Templates* list pane is initially displayed as a closed tab in the *RMX Web Client* main window. The number of saved *Conference Templates* is indicated on the tab.

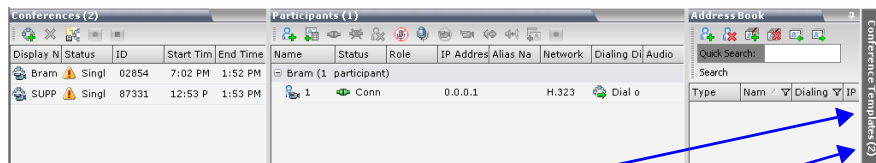

Conference Templates Tab

Number of Saved Conference Templates

Clicking the tab opens the *Conference Templates* list pane.

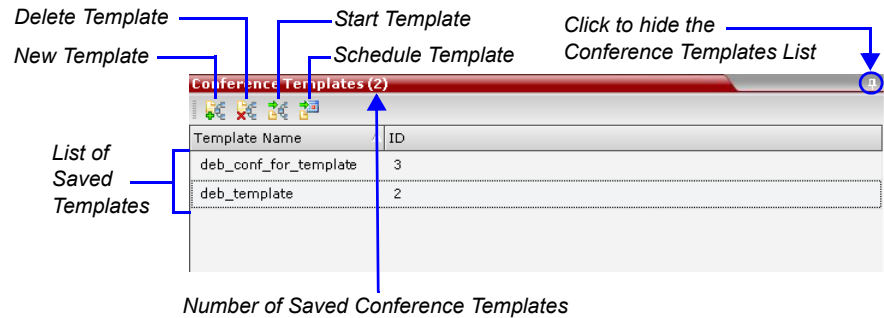

Hide the *Conference Templates* list pane by clicking the anchor pin (📌) button in the top right corner of the pane.

The *Conference Templates* list pane closes and a tab appears in the top right corner of the screen.

Customizing the Main Screen

You can customize the main screen according to your preferences. Pane sizes can be changed, column widths can be adjusted and data lists can be sorted.



Customization settings are automatically saved for each logged-in user. The next time the *RMX Web Client* is opened, the main screen settings appear as they were when the user exited the application.

To re-size a pane:

- Move the pointer over the pane border and when the pointer becomes a click and drag the pane border to the required size and release the mouse button.

To adjust column width:

- In the column header row, place the pointer on the vertical field-separator bar of the column.
- When the pointer becomes a , click and drag the field separator bar to the required column size and release the mouse button.

To sort the data by any field (column heading):

- 1 In the *Conference* list or *List* view pane, click on the column heading of the field to be used for sorting.

A ▾ or ▲ symbol appears in the column heading indicating that the list is sorted by this field, as well as the sort order.

- 2 Click on the column heading to toggle the column's sort order.

To change the order of columns in a pane:

- ☞ Click the column heading to be moved and drag it to its new position. When a set of red arrows appears indicating the column's new position, release the mouse button.

To restore the RMX 2000 display window to its default configuration:

- ☞ On the *RMX 2000* menu, click **View > Restore RMX Display Defaults**.

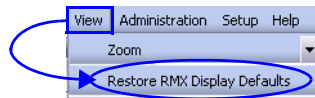

Customizing the RMX Management Pane

The *RMX Management* pane can be viewed either as a list or as a toolbar.

To switch between Toolbar and List Views:

- ☞ In the *RMX Management* pane, click the *Toolbar View* button to switch to Toolbar view.
- ☞ In the *RMX Management* pane, click the *Toolbar View* button to switch to Toolbar view. In Toolbar view, click the *List View* button to switch back to List view.

Toolbar View Button

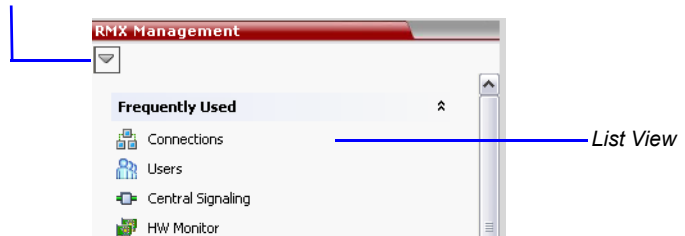



List View Button



You can move items between the *Frequently Used* and *Rarely Used* sections depending on the operations you most commonly perform and the way you prefer to work with the *RXM Web Client*.

This only works in *List* view because in *Toolbar* view, all items are represented by icons.



To expand or Collapse the Frequently Used and Rarely Used sections:

The *Frequently Used* and *Rarely Used* sections can be expanded or collapsed by clicking the  and  buttons.

To move items within and between the Frequently Used and Rarely Used sections:

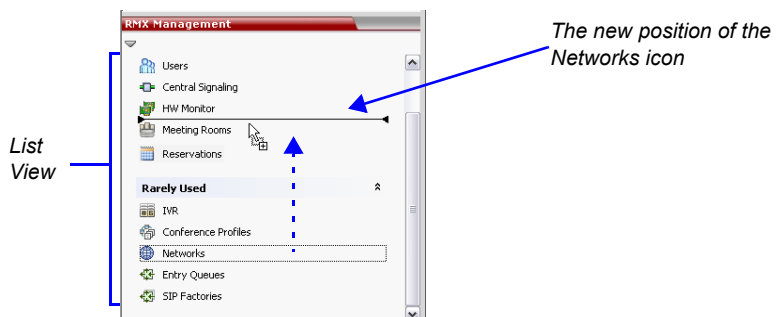
- 1 In the *RMX Management* pane click and drag the icon of the item that you wish to move.
An indicator line () appears indicating the new position of the icon.
- 2 Release the mouse button when the icon is in the desired position.



The *Frequently Used* and *Rarely Used* sections can be expanded or collapsed by clicking the  and  buttons.

Starting a Conference

There are several ways to start a conference:

- Clicking the *New Conference* button in the *Conferences* pane. For more information, see "Starting a Conference from the Conferences Pane" on page **3-16**.
- Dialing in to a Meeting Room.
 - A Meeting Room is a conference that is saved on the MCU. It remains in passive mode until it is activated by the first participant, or the meeting organizer, dialing in.

For more information about Meeting Rooms, see the *RMX 1500/2000/4000 Administrator's Guide*, "Meeting Rooms" on page **3-1**.

- Dialing in to an Ad Hoc Entry Queue which is used as the access point to the MCU.

For a detailed description of Ad Hoc Entry Queues, see the *RMX 1500/2000/4000 Administrator's Guide*, "Entry Queues" on page **4-1**.

- Start a *Reservation*:
 - If the *Start Time* of the *Reservation* is past due the conference becomes ongoing immediately.
 - If the *Start Time* of the *Reservation* is in the future the conference becomes ongoing, at the specified time on the specified date.

For more information, see "Starting a Reservation" on page **3-27**.

- Start any *Conference Template* saved in the *Conference Templates* list. For more information, see "Starting an Ongoing Conference From a Template" on page **3-29**.

- Clicking on the link included in a *Microsoft Outlook Polycom Meeting Invitation* or by manually dialing the numbers displayed in the invitation using the endpoint's numeric input device.

- Attendees that have received an invitation to a *Polycom Meeting* via the *Polycom Conferencing Add-in for Microsoft Outlook* can start a conference by being the first invited attendee to click on a link in the *Meeting Invitation* displayed on his/her workstation or calendaring enabled endpoint, or manually dial in to the meeting using the *Polycom Conference* information included in the *Meeting Invitation*.

For more information see the *RMX 1500/2000/4000 Administrator's Guide*, "Polycom Conferencing for Microsoft Outlook®" on page **9-1**.

Starting a Conference from the Conferences Pane

To start a conference from the Conference pane:

- 1 In the *Conferences* pane, click the **New Conference** (🌐) button.

The *New Conference – General* dialog box opens.

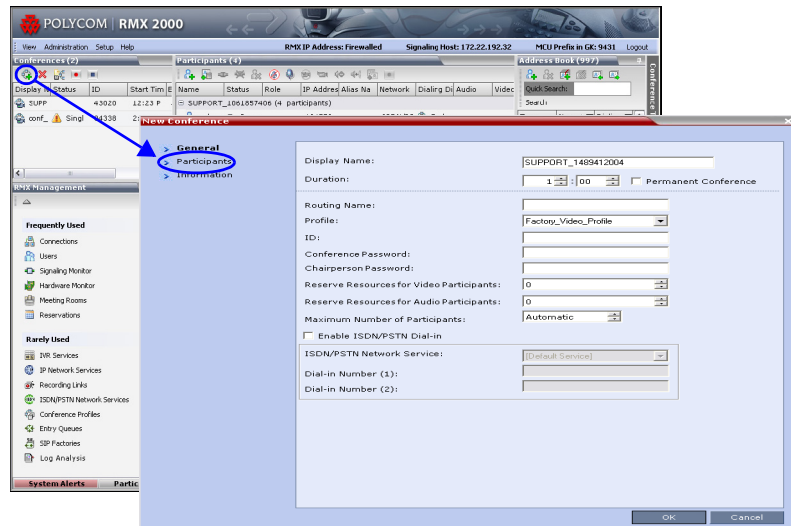

The system displays the conference's default *Name*, *Duration* and the default *Profile*, which contains the conference parameters and media settings.

The RMX automatically allocates the conference *ID*, when the conference starts.

In most cases, the default conference *ID* can be used and you can just click **OK** to launch the conference. If required, you can enter a conference *ID* before clicking **OK** to launch the conference.

If you are the meeting chairperson or organizer using the *RMX Web Client* to start your own meeting, you need to communicate the default conference *ID* (or the one you created) to the other conference participants so they can dial in.

You can use the *New Conference - General* dialog box to modify the conference parameters. If no defined participants are to be added to the conference, or you do not want to add additional information, click **OK**.

General Tab

2 Define the following parameters:

Table 3-2 *New Conference – General Options*

Field	Description
<i>Display Name</i>	<p>The Display Name is the conferencing entity name in native language character sets to be displayed in the RMX Web Client.</p> <p>In conferences, Meeting Rooms, Entry Queues and SIP factories the system automatically generates an ASCII name for the <i>Display Name</i> field that can be modified using Unicode encoding.</p> <ul style="list-style-type: none"> English text uses ASCII encoding and can contain the most characters (length varies according to the field). European and Latin text length is approximately half the length of the maximum. Asian text length is approximately one third of the length of the maximum. <p>The maximum length of text fields also varies according to the mixture of character sets (Unicode and ASCII).</p> <p>Maximum field length in ASCII is 80 characters. If the same name is already used by another conference, Meeting Room or Entry Queue, the RMX displays an error message requesting you to enter a different name.</p> <p>Note: This field is displayed in all tabs.</p>
<i>Duration</i>	<p>Define the duration of the conference in hours using the format HH:MM (default 01:00).</p> <p>Note: This field is displayed in all tabs.</p>
<i>Permanent Conference</i>	<p>Check this box to make this conference a <i>Permanent Conference</i>: an ongoing conference with no pre-determined <i>End Time</i> continuing until it is terminated by an administrator, operator or chairperson. For more information see the <i>RMX 1500/2000/4000 Administrator's Guide</i> "Permanent Conference" on page 2-76.</p> <p>Note: This field is displayed in all tabs.</p>

Table 3-2 *New Conference – General Options (Continued)*

Field	Description
<i>Routing Name</i>	<p><i>Routing Name</i> is the name with which ongoing conferences, Meeting Rooms, Entry Queues and SIP Factories register with various devices on the network such as gatekeepers and SIP server. This name must be defined using ASCII characters.</p> <p>Comma, colon and semicolon characters cannot be used in the <i>Routing Name</i>.</p> <p>The <i>Routing Name</i> can be defined by the user or automatically generated by the system if no <i>Routing Name</i> is entered as follows:</p> <ul style="list-style-type: none"> • If ASCII characters are entered as the <i>Display Name</i>, it is used also as the <i>Routing Name</i> • If a combination of Unicode and ASCII characters (or full Unicode text) is entered as the <i>Display Name</i>, the <i>ID</i> (such as Conference ID) is used as the <i>Routing Name</i>. <p>If the same name is already used by another conference, Meeting Room or Entry Queue, the RMX displays an error message and requests that you to enter a different name.</p>
<i>Profile</i>	<p>The system displays the name of the default Conference Profile. Select the required Profile from the list.</p> <p>The Conference Profile includes the Conference line rate, media settings and general settings.</p> <p>For a detailed description of Conference Profiles, see the <i>RMX 1500/2000/4000 Administrator's Guide</i>, "Conference Profiles" on page 1-1.</p>
<i>ID</i>	<p>Enter the unique-per-MCU conference ID. If left blank, the MCU automatically assigns a number once the conference is launched.</p> <p>This ID must be communicated to conference participants to enable them to dial in to the conference.</p>

Table 3-2 *New Conference – General Options (Continued)*

Field	Description	
<i>Conference Password</i>	<p>Enter a password to be used by participants to access the conference. If left blank, no password is assigned to the conference.</p> <p>This password is valid only in conferences that are configured to prompt for a conference password.</p>	<p>These fields are numeric and have a default length of 4 characters. The administrator can modify them in the <i>Setup - System Configuration</i> settings. For more information, see <i>RMX Administrator's Guide</i>, "System Configuration" on page 18-5.</p>
<i>Chairperson Password</i>	<p>Enter a password to be used by the RMX to identify the <i>Chairperson</i> and grant him/her additional privileges. If left blank, no chairperson password is assigned to the conference.</p> <p>This password is valid only in conferences that are configured to prompt for a chairperson password.</p>	
<i>Reserve Resources for Video Participants</i>	<p>Enter the number of video participants for which the system must reserve resources.</p> <p>Default: 0 participants.</p> <p>Maximum:</p> <ul style="list-style-type: none"> • MPM Mode: 80 participants. • MPM+ Mode: 160 participants. • MPMx Mode: 180 participants (Double card) • MPMx Mode: 90 participants (Single card) 	

Table 3-2 *New Conference – General Options (Continued)*

Field	Description
<i>Reserve Resources for Audio Participants</i>	<p>Enter the number of audio participants for which the system must reserve resources. Default: 0 participants. Maximum:</p> <ul style="list-style-type: none"> • MPM Mode: 80 participants. • MPM+ Mode: 200 participants (if all ports are set to Audio Only). • MPMx Mode: 720 participants (Double card, with all ports are set to Audio Only). • MPMx Mode: 360 participants (Single card, with all ports are set to Audio Only).
<i>Maximum Number of Participants</i>	<p>Indicate the total number of participants that can be connected to the conference. The automatic setting indicates that the maximum number of participants that can be connected to the MCU is determined according to resource availability.</p> <p>Note: If a number is specified, it should be large enough to accommodate the participants specified in the <i>Reserve Resources for Video/Audio Participants</i> fields.</p>
<i>Enable ISDN/PSTN Dial-in</i>	<p>Select this check box if you want ISDN and PSTN participants to be able to connect directly to the conference.</p>
<i>ISDN/PSTN Network Service</i>	<p>The default Network Service is automatically selected. A different ISDN/PSTN Network Service can be selected from the Network Services list.</p>
<i>Dial-in Number (1)</i>	<p>Leave this field blank to let the system automatically assign a number from the dial-in range defined for the selected ISDN/PSTN Network Service. To manually define a dial-in number, enter a unique number from the dial-in number range defined for the selected Network Service. This number cannot be assigned to another Conference/Reservation/Meeting Room/Gateway Profile</p>

Table 3-2 New Conference – General Options (Continued)

Field	Description
<i>Dial-in Number (2)</i>	By default, the second dial-in number is not defined. To define a second-dial-in number, enter a required number from the dial-in number range defined for the selected Network Service.

- 3 If all participants are undefined, dial-in and no additional information is required for the new conference, click **OK**.
- 4 To add participants from the *Participants Address Book* or to define participants (mainly dial-out participants) click the *Participants* tab.

Participants Tab



This procedure is optional.

The *Participants* tab is used to add participants to the conference from the *Address Book*.

It is also used to add defined dial-out participants to the conference. Defined dial-out participants are connected to the conference automatically when the conference is launched, unless the *Dial Out Manually* option is selected.

- 5 Click the **Participants** tab.
The *Participants* tab opens.

The screenshot shows the 'New Conference' dialog box with the 'Participants' tab selected. The 'Participants List' is empty. The 'Display Name' field contains 'SUPPORT_1131756460'. The 'Duration' is set to '1:00' and 'Permanent Conference' is unchecked. The 'Participants List' has columns for Name, IP Address, Alias Na, Network, Dialing D, and Encryption. Below the list are buttons for 'New', 'Remove', and 'Add from Address Book'. The 'Lecturer' dropdown is empty and 'Dial Out Manually' is unchecked. 'OK' and 'Cancel' buttons are at the bottom right.

When defining a new conference, the *Participants List* is empty.

The following table describes the information displayed in the *Participants List* and the operations that can be performed.

Table 3-3 *New Conference – Participants Tab*

Column / Button	Description
Participants List	
<i>Name</i>	A Unicode field that displays the participant's name and an icon representing the endpoint type: <i>Audio Only</i> or <i>Video</i> .
<i>IP Address/Phone</i>	Indicates the IP address or phone number of the participant's endpoint. <ul style="list-style-type: none"> For dial-out connection, displays the IP address or phone number of the endpoint called by the Polycom RMX 1500/2000/4000. For dial-in connection, displays the participant's IP address or phone number used to identify and route the participant to the appropriate conference.
<i>Alias Name/SIP Address (IP Only)</i>	Displays the alias name of an H.323 endpoint or the SIP URL.
<i>Network</i>	The network communication protocol used by the endpoint to connect to the conference: <i>H.323</i> , <i>SIP</i> or <i>ISDN/PSTN</i> .
<i>Dialing Direction</i>	Dial-in – The participant dials in to the conference Dial-out – The RMX dials out to the participant
<i>Encryption</i>	Displays whether the endpoint uses encryption for its media. The default setting is <i>Auto</i> , indicating that the endpoint must connect according to the conference's encryption setting. Note: The H.320 protocol (ISDN/PSTN) does not support encryption.

Table 3-3 *New Conference – Participants Tab (Continued)*

Column / Button	Description
Buttons	
New	Click to define a new participant. For more information, see the <i>RMX 1500/2000/4000 Administrator's Guide</i> , "Adding a new participant to the Address Book Directly" on page 5-4.
Remove	Click to remove the selected participant from the conference.
Add from Address Book	Click to add a participant from the <i>Address Book</i> to the conference.
Lecturer	
<i>Lecturer</i>	This option is used to activate the <i>Lecture Mode</i> . Select the participant you want to designate as <i>Lecturer</i> from the list of conference participants. The Lecturer can be selected once the conference is running and participants are connected.
<i>Dial Out Manually</i>	Select this option to designate an RMX User-controlled dial-out conference connection. When checked, the user must connect each of the dial-out participants who remain on standby until they are connected to the conference.

Participants can be added to the conference in the following methods:

- Defining a new participant during the definition of the conference (clicking the New button).
- Adding pre-defined participants from the *Address Book* by either selecting the participants from the list or dragging and dropping the participants from the *Address Book* to the Participants list.
- Dial-in participants can connect to the conference after it was started (without using the *New Conference - Participants* dialog box).

- Once the conference has started, participants can be added to a conference directly from the *Participants Address Book* without having to use the *New Conference – Participants* tab. For more details, see "Adding Participants from the Address Book" on page 3-61.

To add participants from the Address Book:

- 6 In the *Participants List*, click the **Add from Address Book** button to open the *Participants Address Book*.

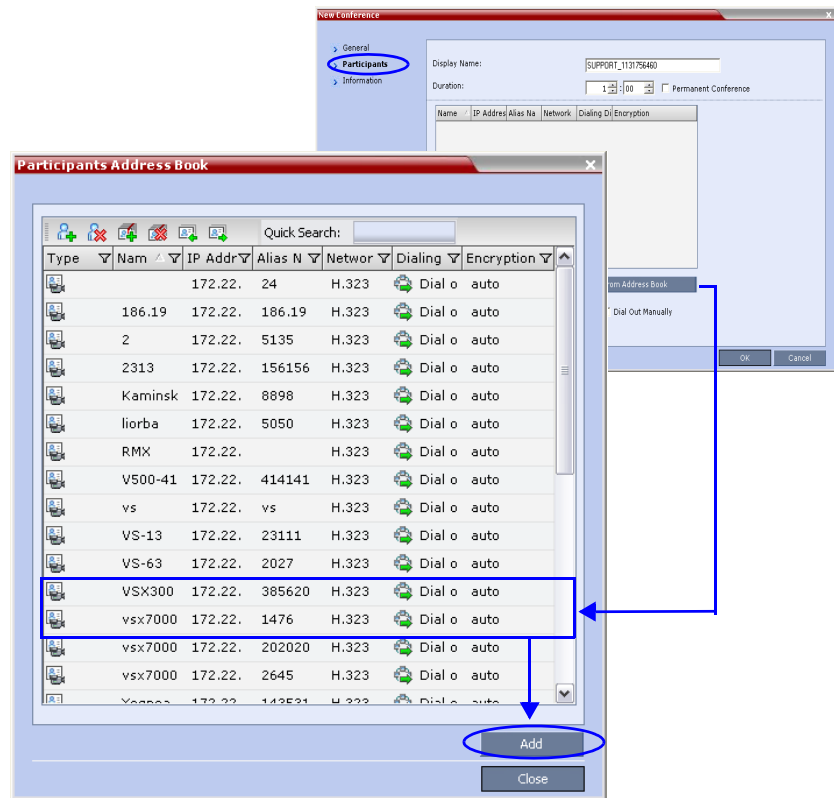

- 7 In the *Participants Address Book*, select the participants that you want to add to the conference and click the **Add** button.

Standard Windows multiple selection techniques can be used in this procedure.

- 8 The selected participants are assigned to the conference and appear in the *Participant List*.
- 9 Select additional Participants or click the **Close** button to return to the *Participants* tab.

Information Tab

In the *Info* fields, you can add general information about the conference, such as contact person name, company name, billing code, etc.

This information is written to the *Call Detail Record (CDR)* when the conference is launched.

Changes made to this information once the conference is running are **not** saved to the *CDR*.



This procedure is optional.
The information entered into these fields does not affect the conference.

To add information to the conference:

- 10 Click the **Information** tab.

The *Information* tab opens.

The screenshot shows the 'New Conference' dialog box with the 'Information' tab selected. The 'Information' tab is circled in blue. The dialog box contains the following fields:

- Display Name: SUPPORT_1823702646
- Duration: 1:00 (with increment and decrement buttons) and a checkbox for 'Permanent Conference'.
- Info1: [Text input field]
- Info2: [Text input field]
- Info3: [Text input field]
- Billing Info: [Text input field]

At the bottom right, there are 'OK' and 'Cancel' buttons.

11 Enter the following information:**Table 3-4** *New Conference – Info Options*

Field	Description
<i>Info1, 2, 3</i>	There are three information fields that allow you to enter general information for the conference such as company name, contact person etc. Unicode can be used in these fields. The maximum length of each field is 80 characters.
<i>Billing</i>	Enter the conference billing code if applicable.

12 Click OK.

An entry for the new conference appears in the *Conferences* pane.

If no participants were defined for the conference or as long as no participants are connected, the indication *Empty* and a warning icon (⚠️) appear in the *Status* column in the *Conferences* pane.

The status changes when participants connect to the conference.

If no participant connects within the time specified in the *Conference Profiles > Auto Terminate > Before First Joins* field, the conference is automatically terminated by the system.

Starting a Reservation

To start a conference from the Reservation Calendar:

- 1 In the *RMX Management* pane, click the **Reservations** entry (📅). The *Reservation Calendar* is displayed.
- 2 Click the **New Reservation** (+) button.

The screenshot displays the RMX Management interface. At the top, the status bar shows "RMX IP Address: 172.22.192.28", "Signaling Host: 172.22.192.32", and "MCU Prefix in GK: 9431". Below this is the "Reservations List" window, which contains a table with columns for "Display", "N", "Status", "ID", "Start Time", and "End Time". The table lists several test reservations, all with a status of "Empt". To the right of the table is a calendar grid showing days from Sunday, 11/2/2008, to Saturday, 11/8/2008, and times from 08:00 to 22:00. Existing reservations are shown as blocks: "Sales" on Tuesday, 11/5/2008 at 12:00; "Logistics" on Wednesday, 11/6/2008 at 15:00; and "SUPP CRT" on Thursday, 11/7/2008 at 19:00. Below the Reservations List is the "RMX Management" pane, which has a "Frequently Used" section containing icons for "Connections", "Users", "Signaling Monitor", "Hardware Monitor", "Meeting Rooms", "Address Book", and "Reservations". The "Reservations" icon is highlighted with a blue box. A blue arrow points from this icon to the "+" button in the top right corner of the Reservations List window.

The *New Reservation – General* tab dialog box opens.

- 3 Optional.** Select the **Enable ISDN/PSTN Dial-in** check box if you want ISDN and PSTN participants to be able to connect directly to the conference.
- 4** If *Enable ISDN/PSTN Dial-in* option is selected, either enter a dial-in number, or leave the *Dial-in Number* field blank to let the system automatically assign a number from the dial-in range defined for the selected ISDN/PSTN Network Service.
- 5** Click the **OK** button.

A confirmation box is displayed stating that the *Reservation* time is past due and that the conference will become ongoing.

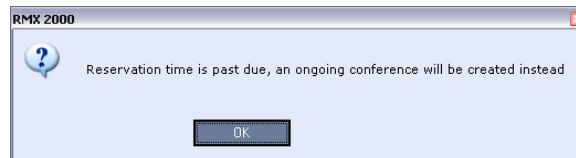

- 6** Click **OK**.

The conference is started. If an ISDN/PSTN dial-in number was assigned to the conference either automatically or manually, this number can be viewed in the *Conferences* pane.

For more information about *Reservations*, see the *RMX 1500/2000/4000 Administrator's Guide*, "Reservations" on page 6-1.

Starting an Ongoing Conference From a Template

An ongoing conference can be started from any Conference Template saved in the *Conference Templates* list.

To start an ongoing conference from a Template:

- 1 In the *Conference Templates* list, select the Template you want to start as an ongoing conference.
- 2 Click the **Start Conference from Template** (🗑️) button.
or
Right-click and select **Start Conference from Template**.

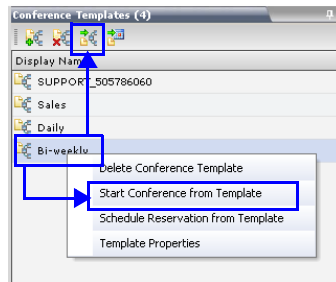

The conference is started.



If a Conference Template is assigned a dial-in number that is already assigned to an ongoing conference, Meeting Room, Entry Queue or Gateway Profile, when the template is used to start an ongoing conference or schedule a reservation it will not start. However, the same number can be assigned to several conference templates provided they are not used to start an ongoing conference at the same time. If a dial in number conflict occurs prior to the conference's start time, an alert appears: "ISDN dial-in number is already assigned to another conferencing entity" and the conference cannot start.

The name of the ongoing conference in the *Conferences* list is taken from the Conference Template *Display Name*.

Participants that are connected to other ongoing conferences when the template becomes an ongoing conference are not connected.



If an ongoing conference, Meeting Room or Entry Queue with the same *Display Name*, *Routing Name* or *ID* already exist in the system, the conference will not be started.

For detailed description of Conference Templates, see *RMX 1500/2000/4000 Administrator's Guide*, "Conference Templates" on page **8-1**.

Starting a Video Meeting from a Microsoft Outlook Polycom Meeting Invitation

Polycom Conference information is included in the meeting invitation sent by *Outlook* to each meeting attendee. The following example shows a *Polycom Conference* invitation as received by *Outlook* running on a workstation.

Meeting
 Bell, Maria
 Sent: 18:56 11/03/2010
 To: O'Brien, Sean

You have been invited to join a meeting using the Polycom® conferencing service.

[Join the meeting using Polycom CMA Desktop](#)
[Join the meeting using Microsoft® Office Communicator](#)

MEETING DETAILS
 Video Number: 7218817
 Meeting Password: 12
[View the meeting stream or recording](#)

TECHNICAL SUPPORT
 If you need help, contact technical support at

- 1.800.555.2222
- help@example.com
- <http://help.example.com/video-calendaring>

NOTICE
 Polycom® conferencing service can be used to record meetings. By participating in this meeting, you agree that your communications may be monitored or recorded at any time during the meeting.

DO NOT EDIT BELOW THIS LINE
 --BEGIN POLYCOM VMR ENCODED TOKEN--
 UE9MWUNPTS1BVURJT05VTUJFUJ19CIBPTFIDT00tQVWESU9OVU1CRVDxPQpQT0xZQ09NLVNUUKVBTU1FRVRJTKc9dHJ1ZQpPTFIDT00tQ0hBSVJQQVNTV09SRFJFUVJUKVEPWZhbHNCIBPTFIDT00tU0IHtKfMSU5HUE9TVEZJWD1Ac2lwLmV4YW1wbGU RD0xMgpQT0xZQ09NLVZFUJNT049MQo=
 --END POLYCOM VMR ENCODED TOKEN--

Maria Bell
 Engineer
 Polycom

If the attendee is the first to connect to the meeting, he/she starts the meeting by clicking on the link included in the invitation or by manually dialing the numbers displayed using the endpoint's numeric input device. For more information see the *RMX 1500/2000/4000 Administrator's Guide*, "Polycom Conferencing for Microsoft Outlook®" on page 9-1.

Connecting to a Conference

Direct Dial-in

Direct dial-in connection to conferences and Meeting Rooms is available to all endpoints.

Participants must be provided with a dialing string which can vary according to the network type, conference password and chairperson password.

Participants dial the conference dial-in string and are connected to the conference IVR Service. Once the correct information, such as the conference password and chairperson password are entered, the participants are connected to the conference.

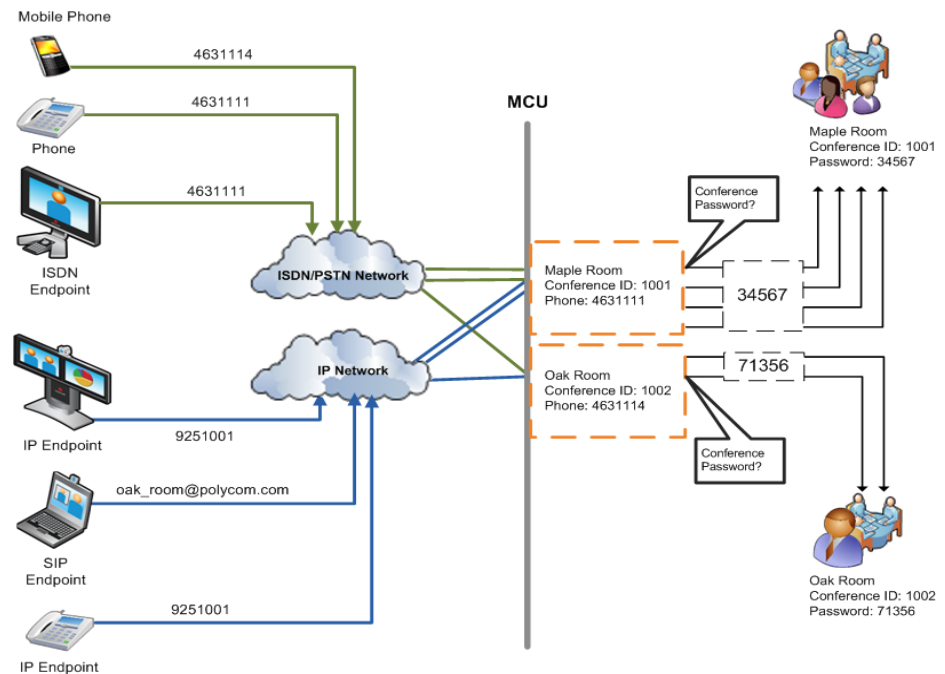

Figure 3-1 Dial-in Connection via IVR System

The MCU can be configured to enable the chairperson to use the chairperson password as the conference password without the need to enter the conference password.

H.323 Participants

For H.323 participants, the dialing string is composed of the MCU prefix in the Gatekeeper and the conference ID.

Example:

Prefix in gatekeeper	925
Conference ID	1001
Conference Name	Maple_Room

 The participant dials 9251001 or 925Maple_room

If there is no gatekeeper defined for the network, H.323 participants dial the MCU's signaling host IP address and the conference ID, separated by ##.

Example:

MCU (Signaling Host) IP address	172.22.30.40
Conference ID	1001

 The participant dials 172.22.30.40##1001

SIP Participants

For SIP participants the dialing string is composed of the conference routing name and domain name in the following format:

```
conference_routing_name@domain_name
```

Example:

Conference routing name	1001
-------------------------	------

 The participant dials 1001@polycom.com

ISDN/PSTN Participants

Dial-in ISDN and PSTN participants dial one of the dial-in numbers assigned to the conference/Meeting Room/Reservation/Conference Template, including the country and area code (if needed). They are routed to their conference according to the dial-in number.

Example:

Assigned dial-in number	4631111
-------------------------	---------

The participant dials	4631111
-----------------------	---------

Connecting to a Polycom Conference from an Outlook Meeting Invitation

Attendees that have received a *Meeting Invitation* via *Outlook* using the *Polycom Conferencing Add-in for Microsoft Outlook*, connect by clicking on the link included in the invitation or by manually dialing the numbers displayed using the endpoint's numeric input device.

The screenshot shows an Outlook meeting invitation from Maria Bell. It includes two blue arrows pointing to the meeting links: one labeled "Click Link to Connect" pointing to the Polycom CMA Desktop link, and another labeled "Dial Manually to Connect" pointing to the video number "7218817".

Meeting
Bell, Maria
Sent: 18:56 11/03/2010
To: O'Brien, Sean

You have been invited to join a meeting using the Polycom® conferencing service.

[Join the meeting using Polycom CMA Desktop](#)
[Join the meeting using Microsoft® Office Communicator](#)

MEETING DETAILS
Video Number: 7218817
Meeting Password: 12
[View the meeting stream or recording](#)

TECHNICAL SUPPORT
If you need help, contact technical support at

- 1.800.555.2222
- help@example.com
- <http://help.example.com/video-calendaring>

NOTICE
Polycom® conferencing service can be used to record meetings. By participating in this meeting, you agree that your communications may be monitored or recorded at any time during the meeting.

DO NOT EDIT BELOW THIS LINE
--BEGIN POLYCOM VMR ENCODED TOKEN--
UE9MWUNPTS1BVURJT05VUJFUJI9CIBPTFD00tQVWESU9OVU1CRVIXPpQT0xZQ09NLVNUUkVBTU1FRVJTKc9dH1ZQpPTFD00tQ0hBSVJQVNTV09SRFJFUVVJUKVEPWZhbHNICIBPTFD00tU0IHtkFMSU5HUE97VEZJWD1Ac2lwLmV4YW1wbGU RD0xMgpQT0xZQ09NLVZFUJNT049MQ0=
--END POLYCOM VMR ENCODED TOKEN--

Maria Bell
Engineer
Polycom

For more information see the *RMX 1500/2000/4000 Administrator's Guide*, "Polycom Conferencing for Microsoft Outlook®" on page 9-1.

Entry Queue Access

Access via an Entry Queue allows all participants to dial the same entry point that acts as a routing lobby. Once in the Entry Queue, participants are guided to the conference according to the conference ID they enter.

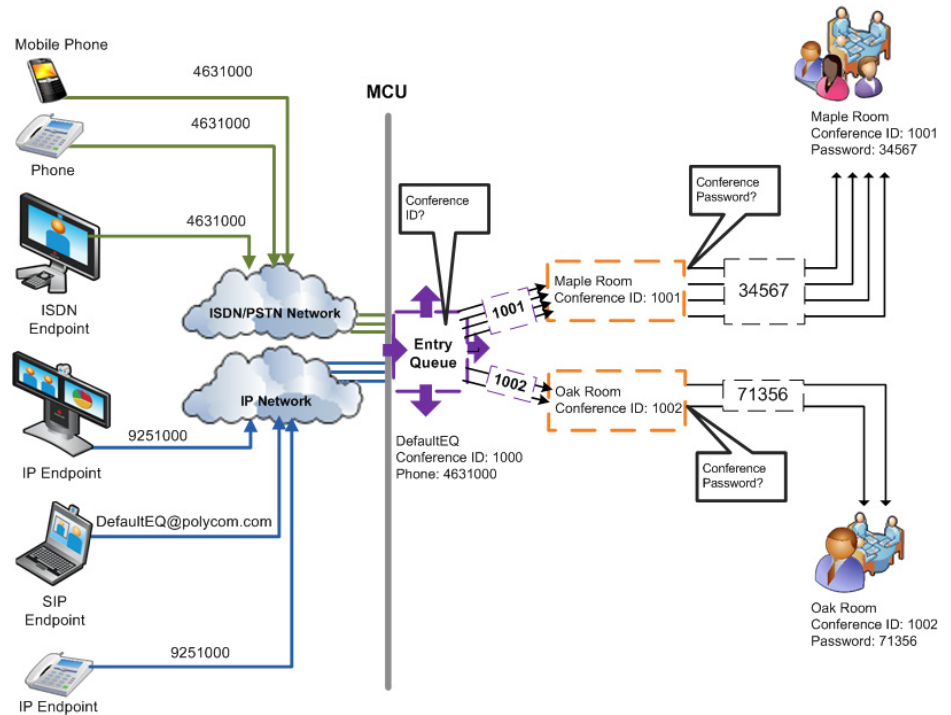

Figure 3-2 Dial-in Connection via Entry Queue

H.323 Participants

Dialing is executed in the same way as for conferences, where the Entry Queue ID/Name replaces the Conference ID/Name.

H.323 participants dial [Gatekeeper Prefix][Entry Queue ID/Name].

Example:

Prefix in gatekeeper	925
Entry Queue ID	1000

☞ The participant dials 9251000

H.323 participants can bypass the Entry Queue IVR voice messages by adding the correct Conference ID of destination conference to the initial dial string:

```
[Gatekeeper Prefix][EQ ID][##Destination Conference ID]
```

Example:

Conference ID 1001

 H.323 participants dial 9251000##1001

H.323 participants can also bypass the conference IVR voice messages by adding the Conference Password to the initial dial string:

```
[Gatekeeper Prefix][EQ ID][##Destination Conference ID][##Password]
```

Example:

Conference ID 1001

Conference Password 34567

 H.323 participants dial 9251000##1001##34567

SIP Participants

Using an Entry Queue minimizes the number of conferences that require registration with the SIP server and enables using one URI address for all dial-in connections, using the format:

```
<Entry Queue routing name>@<domain name>
```

Example:

Entry Queue Routing Name DefaultEQ

Domain Name polycom.com

 SIP participants dial DefaultEQ@polycom.com

ISDN and PSTN Participants

Up to two dial-in numbers can be allocated to an Entry Queue for use by ISDN and PSTN participants.

Calls to numbers within the ISDN and PSTN *Dial-in Range* that are not allocated to an Entry Queue are routed to the *Transit Entry Queue*.

Dial-in ISDN and PSTN participants dial one of the dial-in numbers assigned to the Entry Queue, including the country and area code (if needed).

They are routed to their conference according to the conference ID.

Example:

Entry Queue ID	1000
Assigned Dial-in number	4631000
 ISDN/PSTN participants dial	4631000

Dial-out Participants

Automatic Dial Out

Dial-out participants are defined with their dial-out number. Once they are added to the ongoing conference, the MCU automatically calls them at a rate of 1 dial-out per second, using the default H.323, SIP or ISDN/PSTN Network Service defined for them.

Manual Dial Out

In the manual mode, the RMX user or meeting organizer instructs the conferencing system to call the participant. Dial-out participants must be defined (mainly their name and telephone number) and added to the conference. This mode can only be selected at the conference definition stage and cannot be changed once the conference is running.

Gathering Phase

The *Gathering Phase* of a conference is the time period during which participants are connecting to a conference. It is enabled for the conference in the *Conference Profile - Gathering Settings* dialog box.

During the *Gathering Phase*, a mix of live video from connected endpoints is combined with both static and variable textual information about the conference into a slide which is displayed on all connected endpoints. All connected participants are kept informed about the current conference status including names of connected participants, participant count, participant type (video/audio) etc.

During the *Gathering Phase*, the audio of all participants can be heard, and the video of active speakers is displayed in the video windows as they begin talking.

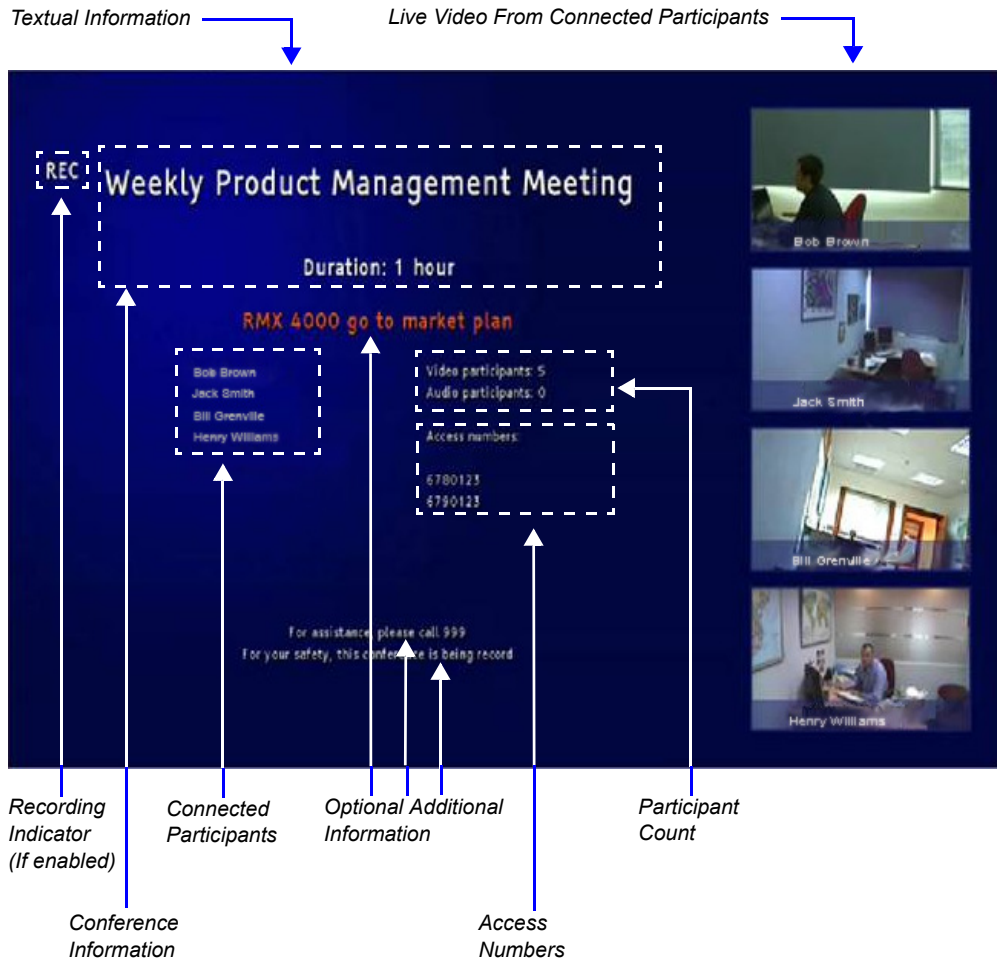

Gathering Phase Guidelines

- The *Gathering Phase* slide can be displayed at any time during the conference by entering the *Show Participants DTMF* code, *88.
- The *Gathering Phase* is not supported in *Video Switching Conferences*.
- The names of the first eight participants to connect are displayed. If eight or more participants connect, the 8th row displays "...".
- **Static text** in the *Gathering Phase* slide such as the field headings: *Organizer, Duration, Video/Audio Participants, Access Number, IP* are always displayed in the language as configured in the *Polycom Virtual Meeting Rooms Add-in for Microsoft Outlook*. The following languages are supported:
 - English
 - French
 - German
 - International Spanish
 - Korean
 - Japanese
 - Simplified Chinese
- **Dynamic text** in the *Gathering Phase* slide such as the meeting name, participants names, access numbers and the additional information entered in the *Info1/2/3* fields of the *Gathering Settings* tab of the conference *Profile* are displayed in the language of the meeting invitation.
- The language of a *Gathering Phase* slide of a conference configured to include a *Gathering Phase* that is not launched by the *Polycom Conferencing Add-in for Microsoft Outlook* is configured by the administrator. Using the *RMX Web Client*, the administrator selects the language for the *Gathering Phase* slide. The language selected can be different to that of the *RMX Web Client* used by the administrator to perform the configuration.
- *Content* can be sent during the *Gathering Phase*. The content is displayed in the large video window of the participant's layout while

the *Gathering* slide is displayed in a smaller video window in the layout.

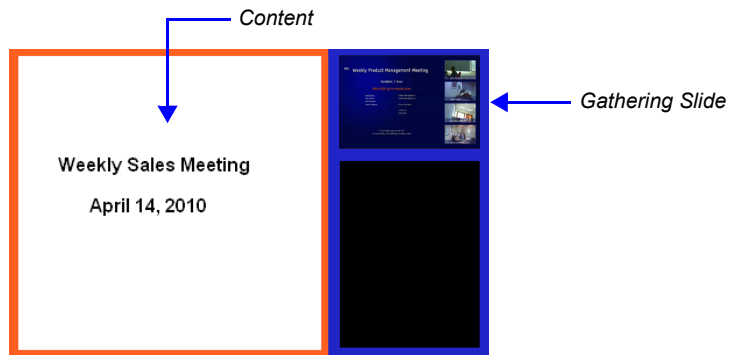

For more information see, the *RMX 1500/2000/4000 Administrator's Guide*, "Gathering Phase" on page **2-36**.

Text Indication in the Video Layout

Endpoint Names

During conferences you can view the names of the endpoints that are connected to the conference in your endpoint's video layout windows. The MCU can display up to 33 characters of the endpoint's name, depending on the window's layout (size).

The following is an example of endpoint name display in the endpoint screen:

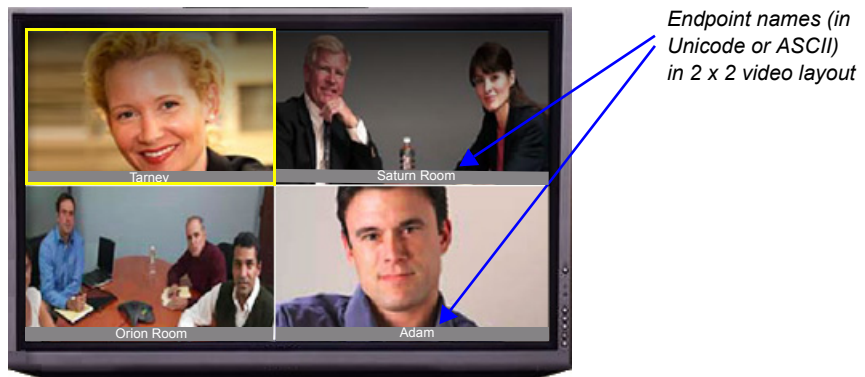

The displayed name is determined as follows:

- The system displays the name that is defined at the endpoint.
- If the endpoint does not send its name:
 - For a defined H.323 or SIP participant:
 - The system displays the name from the participant definition.
 - For an undefined H.323 participant:
 - Display the *H.323 ID* alias.
 - or
 - Display the *E.164* alias.
 - or
 - Display nothing if all the fields are empty.

- For a SIP undefined participant:
 - Display the SIP *DisplayName* field.
or
Display the SIP *Address* (SIP application server).
or
Display the SIP *ContactDisplay* field.
or
Display nothing if all the fields are empty.
- For a defined H.320 participant:
 - The system displays the name from the participant definition.
- For an undefined H.320 participant:
 - Display the *Terminal Command String* (TCS-2) to identify the participant.
or
Display nothing if the string is not received or empty.
- If the endpoint's *Display Name* is changed in the *RMX Web Client*, it overrides all the above.

To change the Display Name:

- 1** In the *Participants* list, double-click the participant or right-click the participant and then select **Participant Properties**.

The *Participant Properties – Media Sources* dialog box opens:

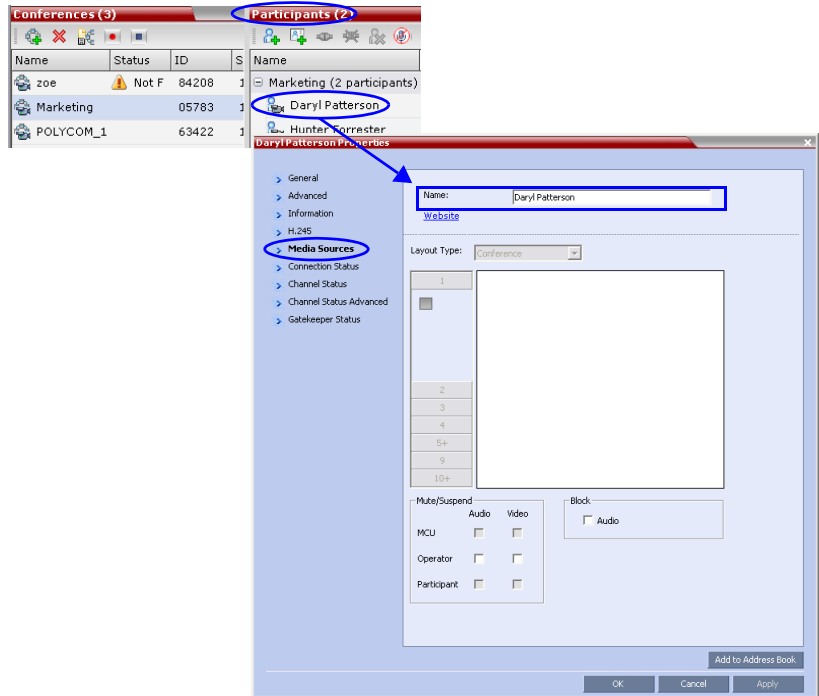

- 2 Enter the new *Display Name* in the *Name* field.
- 3 Click **OK**.

Text Indication

The *Text Indication* appears in the window of the current speaker in the participant's layout in addition to the endpoint name. It displays the conference Secure mode (on or off), total number of connected participants, number of video participants and number of audio participants.

The text indication is automatically displayed when there is a change in the conference Secure state (when Secure is implemented or cancelled) and it appears only for a few seconds (the same duration as the endpoint names).

The conference chairperson or participants can request the display of a *Textual Indication* of the conference's statistics by entering the DTMF code *88 on the endpoint's DTMF input device, such as remote control.

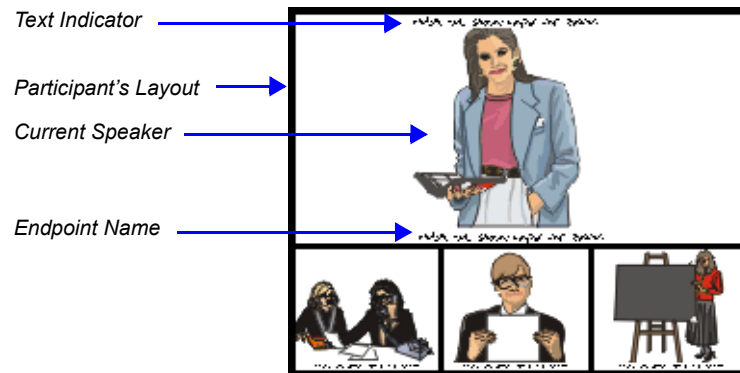

The *Text Indication* is displayed according to the permission set in the *Conference IVR Service*:

- Chairperson permission: Only the chairperson sees the indication
- Everyone permission: All participants see the indication.



Participants connected as Secondary (no video) will be considered as audio participants; defined participant which are not currently connected to the conference (disconnected, redial, disconnecting, etc.) are not counted.

Text Indication can be disabled by adding a new flag to the *System Configuration* and setting its value to NO as follows:
ENABLE_TEXTUAL_CONFERENCE_STATUS=NO.

This setting is recommended for MCUs running *Telepresence* conferences. For more information, see the *RMX 1500/2000/4000 Administrator's Guide*, "System Configuration" on page [18-5](#).

Transparent Endpoint Names

Endpoint name backgrounds are 50% transparent, and while maintaining contrast, do not completely obscure the overlaid video.

The *Endpoint Name Transparency* feature can be disabled by adding a new flag to the *System Configuration* and setting its value to NO as follows:
SITE_NAME_TRANSPARENCY=NO.

For more information, see the *RMX 1500/2000/4000 Administrator's Guide*, "System Configuration" on page [18-5](#).

Permanent Display of Endpoint Names

Endpoint Names can be permanently displayed by adding a new flag to the *System Configuration* and setting its value to YES as follows:
SITE_NAMES_ALWAYS_ON =YES.

For more information, see the *RMX 1500/2000/4000 Administrator's Guide*, "System Configuration" on page [18-5](#).

Closed Caption

When enabled, IP endpoints that support FECC (Far End Camera Control) can also be configured to provide real-time text transcriptions or language translations of the video conference by displaying closed captions.

The captions for a conference may be provided by the captioner who is present in the conference, or the captioner may use a telephone or web browser to listen to the conference audio.

When the captioner sends a unit of text, all conference participants see it on the main monitor for 15 seconds. The text then disappears automatically.

Endpoint Name display is not affected by *Closed Captions* display.

For more information, see the *RMX 1500/2000/4000 Administrator's Guide*, "Closed Captions" on page [2-47](#).

Closed Captions option is enabled by a system flag in the system configuration. For more details about system flags, see the *RMX 1500/2000/4000 Administrator's Guide*, "System Configuration" on page [18-5](#).

Message Overlay

Message Overlay allows messages to be sent to all participants in an ongoing conference.

A maximum of 24 Unicode characters can be sent as a *Message Overlay*.

The message can be set to be displayed at various positions on the screen in different colors, static or scrolling.

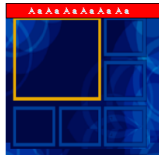

Small Text, White on red, Top, Middle



Small Text, White on yellow, Bottom



For more information see the *RMX 1500/2000/4000 Administrator's Guide* "Message Overlay" on page **2-49**.

Monitoring Ongoing Conferences

Conference monitoring enables you to keep track of conferences and their participants: if all its participants are correctly connected and whether errors or faults have occurred.

Maximum number of participants (voice and video) in a conference:

RMX 1500 MPMx Mode: 360. (90 video).

RMX 2000 MPM Mode: 400. (80 video).

RMX 2000 MPM+ Mode: 800. (160 video).

RMX 2000 MPMx Mode: 720. (180 video).

RMX 4000 MPM+ Mode: 1600. (160 video).

RMX 4000 MPMx Mode: 1440. (180 video).

General Monitoring

All monitoring and operations procedures performed during ongoing conferences can be performed by either of two methods:

- Using the buttons in the toolbars.

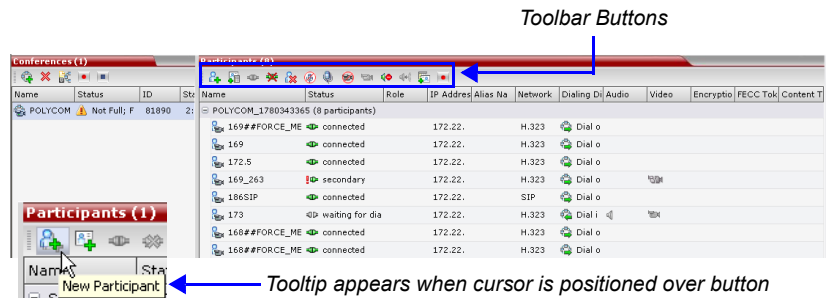

- **Right-clicking** anywhere in the *Conferences* or *Participants* pane and selecting an operation from the menu.

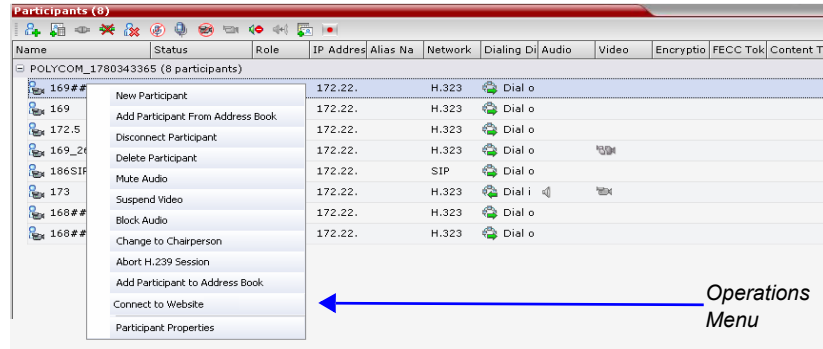

Multi Selection

Using multiple selection, you can monitor and perform simultaneous operations on multiple participants in multiple conferences.

The selected conferences are displayed as sub-lists in the *Participants* list pane.

The sub-lists can be expanded and collapsed by clicking the **+** and **-** sublist control buttons that appear next to the conference name in the sublist headings.

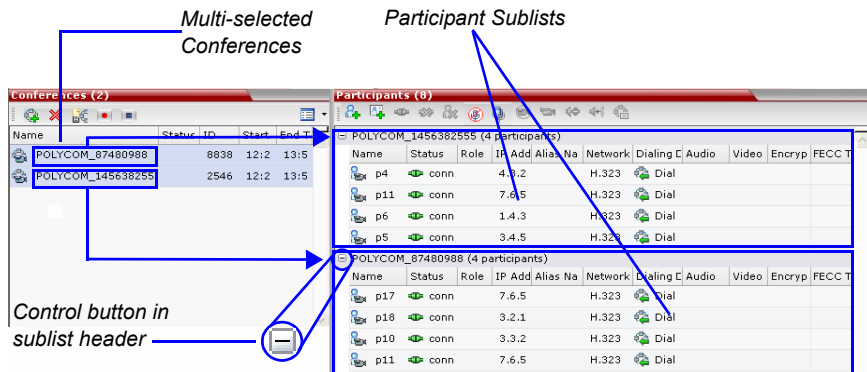

Using the Chairperson Password for Filtering

If you are logged in as a chairperson, the *Chairperson Password* field is displayed. It enables you to search for, and display a list of, ongoing conferences for which you have the password.



To search for an ongoing conference by **Chairperson Password**:

- 1 Click in the *Chairperson Password* field.
- 2 Enter the password to be searched for.
- 3 Click the **Refresh** button.

The *Conferences* list is refreshed and ongoing conferences with the requested password are displayed.

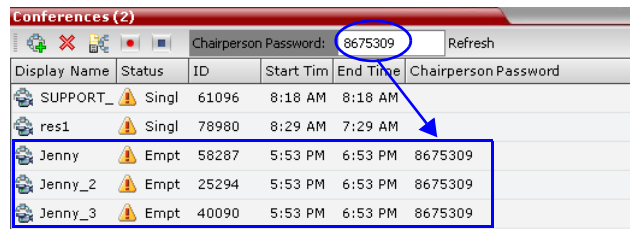

Conference Level Monitoring

Conference level monitoring is available to the administrator, operator and chairperson.

The *Conference List* pane displays information about ongoing conferences.

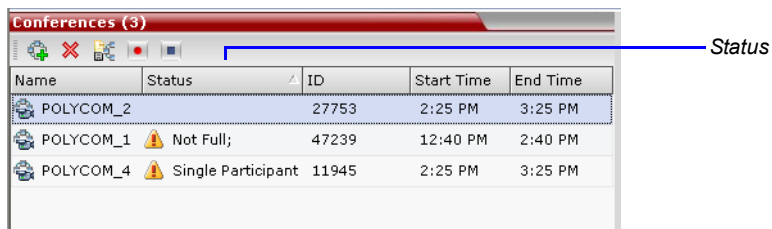

One or more of the status indicators listed in Table 3-5 may appear in the *Status* column.

No status indicator display in the *Status* column means that the conference is running without problems.

One or more of the status indicators listed in Table 3-5 may appear in the *Status* column.

Table 3-5 Conferences – Monitoring Information





Field	Description
<i>Name</i>	Displays conference name and type of conference: <ul style="list-style-type: none"><li data-bbox="615 543 1215 600">•  – Video Conference (including HD CP conferences).<li data-bbox="615 612 1186 638">•  – Conference running in Video Switching mode.<li data-bbox="615 651 1215 736">•  – The conference has been secured using the *71 DTMF code. For details, see "<i>Secured Conference Monitoring</i>" on page 3-53.<li data-bbox="615 748 929 774">•  – Operator Conference.

Table 3-5 Conferences – Monitoring Information (Continued)

Field	Description
<i>Status</i>	<p>Displays the status of the ongoing conference. If there is no problem with the participant's connection no indication is displayed.</p> <p>If one of the following statuses occur, the appropriate indication is displayed, preceded by a warning icon (⚠).</p> <ul style="list-style-type: none"> • Audio – There is a problem with the participant's audio. • Empty – No participants are connected. • Faulty Connection – Participants are connected, but the connection is problematic. • Not Full – Not all the defined participants are connected. • Partially Connected – The connection process is not yet complete; the video channel has not been connected. • Single Participant – Only one participant is connected. • Video – There is a problem with the participant's video. • Content Resource Deficiency – Content will not be sent to legacy endpoints. • Awaiting Operator – A participant has requested operator assistance.
<i>ID</i>	The Conference ID assigned to the conference.
<i>Start Time</i>	Conference start time.
<i>End Time</i>	The time the conference is expected to end.
<i>Dial in Number(1)</i>	The Conference dial in number for ISDN/PSTN participants.

Additional information about the conference can be viewed when accessing the conference properties.

To monitor a conference:

- ☞ In the *Conference List* pane, double click the name of the conference you wish to monitor, or right-click the conference and then click **Conference Properties**.

The *Conference Properties - General* dialog box opens.

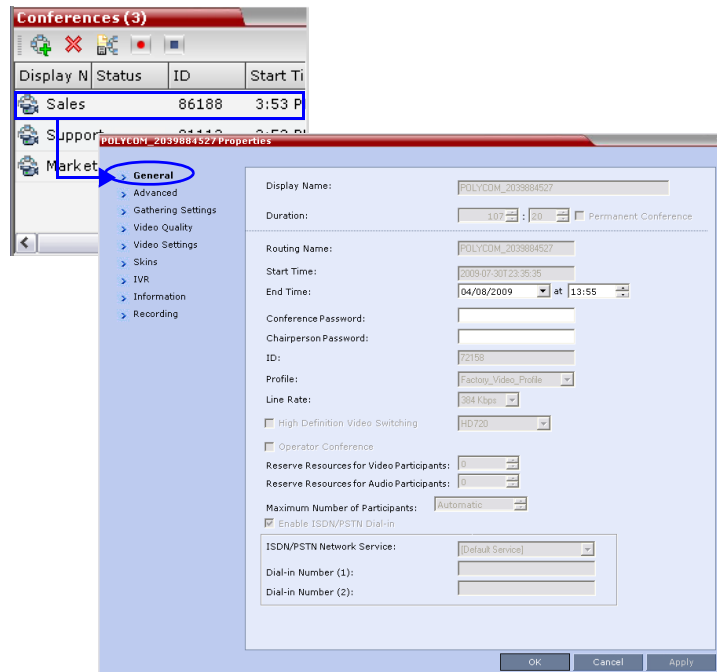

You can view all the conference's properties but those that appear with a gray background cannot be modified.

For more information, see the *RMX 1500/2000/4000 Administrator's Guide*, "Conference Level Monitoring" on page **10-3**.

Roll Call/Audible Tones During an Ongoing Conference

If *Roll Call* is enabled, when a participant joins or leaves a conference, the system plays a voice message to all participants. The audio message consists of the joining or leaving participant's *Roll Call* name followed by either "has joined the conference" or "has left the conference".

These voice messages can be replaced with audio tones. The use of tones requires that the appropriate tone files in *.wav format be uploaded and configured to replace the *Roll Call Joined* and *Roll Call Left* message files.

This feature is enabled or disabled by value of the **IVR_ROLL_CALL_USE_TONES_INSTEAD_OF_VOICE** *System Flag* in *system.cfg*:

- When set to **NO** (default), voice messages are played.
- When set to **YES**, the uploaded tones replace the voice messages.

For more information see the *RMX 1500/2000/4000 Administrator's Guide*, "Modifying System Flags" on page [18-5](#) and "Defining a New Conference IVR Service" on page [14-9](#).

Audio Only Message

H.323 and SIP video participants that are connected as *Secondary (Audio Only)* because of lack of video resources receive an audio message: "All video resources are currently in use. Connecting using audio only" indicating why their video has not connected. For more information see the *RMX 1500/2000/4000 Administrator's Guide*.

Secured Conference Monitoring

When *Secured Conference Mode* is enabled on the RMX, it locks the conference and prevents participants and RMX Users from joining the conference. A *Secured* conference cannot be monitored or controlled in any way. While a conference is in the *Secure Mode*, the RMX User with Administrator authorization cannot view the participants list or any other conference properties, but can manually terminate it.

The conference chairperson can enable or disable the *Secure* mode from the DTMF input device (touch-tone telephone or the endpoint's remote control), using the appropriate DTMF code (the default code is *71). During the secure conference, the chairperson and participants can perform various operations, such as muting, via their DTMF input device using the appropriate DTMF codes. However, because *Secure* conferences cannot be monitored, these operations or status changes are not displayed in the *Conferences* or *Participants* panes.

A special icon  is used to indicate that the conference is in *Secure* mode.

Monitoring Ongoing Gateway Sessions

Ongoing Gateway Sessions that are created when calling the Gateway Profile, are listed in the ongoing Conferences list pane and are monitored in the same way as the conferences.

For more details, see the *RMX 1500/2000/4000 Administrator's Guide*, "Conference Level Monitoring" on page 10-3.

Participant Level Monitoring

Participant Connection Monitoring

When a conference is selected in the *Conference List*, details of its participants appear in the *List* pane.

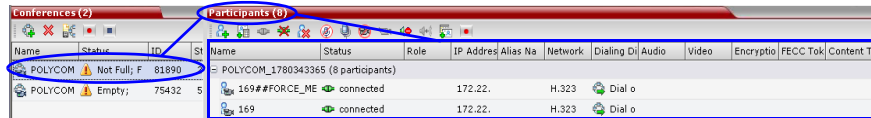

The following participant indicators and properties are displayed:

Table 3-6 Participant Monitoring – Indicators and Properties



Column	Icon/Description
Name	Displays the name and type (icon) of the participant:
	 Audio Participant – Connected via IP phone or ISDN/PSTN.
	 Video Participant – Connected with audio and video channels.

Table 3-6 Participant Monitoring – Indicators and Properties (Continued)









Column	Icon/Description
<i>Status</i>	Displays the connection status (text and icon) of the participant. If there is no problem with the participant's connection no indication is displayed.
	 Connected – The participant is successfully connected to the conference.
	 Disconnected – The participant is disconnected from the conference. This status applies only to defined participants.
	 Waiting for Dial-in – The system is waiting for the defined participant to dial into the conference.
	 Partially Connected – The connection process is not yet complete; the video channel has not been connected.
	 Faulty Connection – The participant is connected, but problems occurred in the connection, such as synchronization loss.
	 Secondary Connection – The endpoint's video channel cannot be connected to the conference and the participant is connected only via audio.
	 Awaiting Individual Assistance – The participant has requested the user's (operator's) assistance.
	 Awaiting Conference Assistance – The participant has requested the operator's assistance for the conference. This usually means that the user (operator) has been requested to join the conference.

Table 3-6 Participant Monitoring – Indicators and Properties (Continued)







Column	Icon/Description	
<i>Role</i>	Displays the participant's role or function in the conference:	
		Chairperson – The participant is defined as the conference chairperson. The chairperson can manage the conference using touch-tone signals (DTMF codes).
		Lecturer – The participant is defined as the conference Lecturer.
		Lecturer and Chairperson – The participant is defined as both the conference Lecturer and Chairperson.
		Cascade Enabled Dial-out Participant – A special participant functioning as a link in a cascaded conference.
		Recording – A special participant functioning as a Recording Link.
<i>IP Address/ Phone</i>	The IP participant's IP address or the ISDN/PSTN participant's phone number.	
<i>Alias Name/ SIP Address</i>	The participant's Alias Name or SIP URI. The alias of an <i>RSS 2000 Recording System</i> if the participant is functioning as a recording link.	
<i>Network</i>	The participant's network connection type – H.323, SIP or ISDN/PSTN.	
<i>Dialing Direction</i>		Dial-in – The participant dialed the conference.
		Dial-out – The MCU dialed the participant.

Table 3-6 Participant Monitoring – Indicators and Properties (Continued)











Column	Icon/Description
<i>Audio</i>	Displays the status of the participant's audio channel. If the participant's audio is connected and the channel is neither muted nor blocked, no indication is displayed.
	 Disconnected – Participant's audio channel is disconnected. This is a defined participant who is waiting to be connected to the conference.
	 Muted – Participant's audio channel is muted. The participant can still hear the conference.
	 Blocked – Transmission of audio from the conference to the participant is blocked.
	 Muted and Blocked - Audio channel is muted and blocked.
<i>Video</i>	Displays the status of the participant's video channel. If there is no problem with the participant's video connection and the channel is neither suspended nor secondary, no indication is displayed.
	 Disconnected – Participant's video channel is disconnected. This is a defined participant who is waiting to be connected to the conference.
	 Suspended – Video transmission from the endpoint to the conference is suspended.
	 Secondary – Participant is connected only through the audio channel due to problems with the video channel.
<i>Encryption</i>	 Indicates that the endpoint is using encryption for its connection to the conference.
<i>FECC Token</i>	 Participant is the holder of the FECC token and has Far End Camera Control capabilities. The FECC token can be allocated to only one participant at a time and remains un-allocated if no participant requests it.

Table 3-6 Participant Monitoring – Indicators and Properties (Continued)

Column	Icon/Description
Content Token	 <p>Participant is the holder of the Content token and has content sharing permission. The Content token can be allocated to only one participant at a time and remains un-allocated if no participant requests it. For more information, see the <i>RMX 1500/2000/4000 Administrator's Guide</i>, "H.239 / People+Content" on page 2-24.</p>

For more information, see the *RMX 1500/2000/4000 Administrator's Guide*, "Participant Level Monitoring" on page 10-15.

Video Preview

Video Preview enables the RMX users to monitor the quality of the video sent and received by the participant and identify possible quality degradation.

To preview the participant video:

- 1 List the conference participants in the *Participants* pane.
- 2 Right-click the participant whose video you want to preview and then click one of the following options:

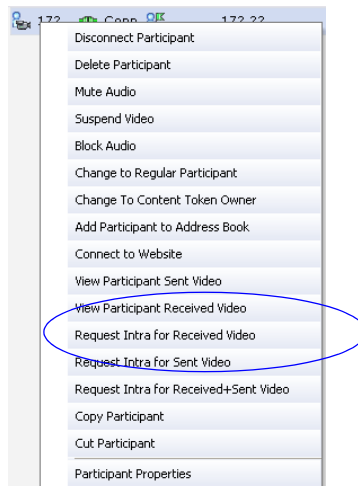

- **View Participant Sent Video** - to display the video sent from the participant to the conference.
- **View Participant Received Video** - to display the video sent from the conference to the participant.

The *Video Preview* window opens.

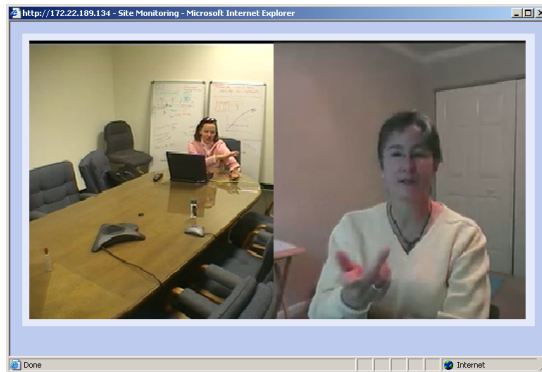

If the video card installed in the PC does not support DirectDraw Acceleration, a black window may be viewed. For more information, including workstation minimum requirements, see the RMX 1500/2000/4000 Administrator's Guide.

Operations Performed During On Going Conferences

Conference Level operations

Changing the Duration of a Conference

The duration of each conference is set when the new conference is created. The default duration of a conference is 1 hour. All conferences running on the RMX are automatically extended as long as there are participants connected to the conference.

A conference's *Duration* can be extended or shortened while it is running, by modifying its scheduled *End Time*.

To extend or shorten a conference manually:

- 1 In the *Conference List* pane, double-click the conference **Name**.
- 2 In the *General* tab, modify the *End Time* fields and click **OK**.

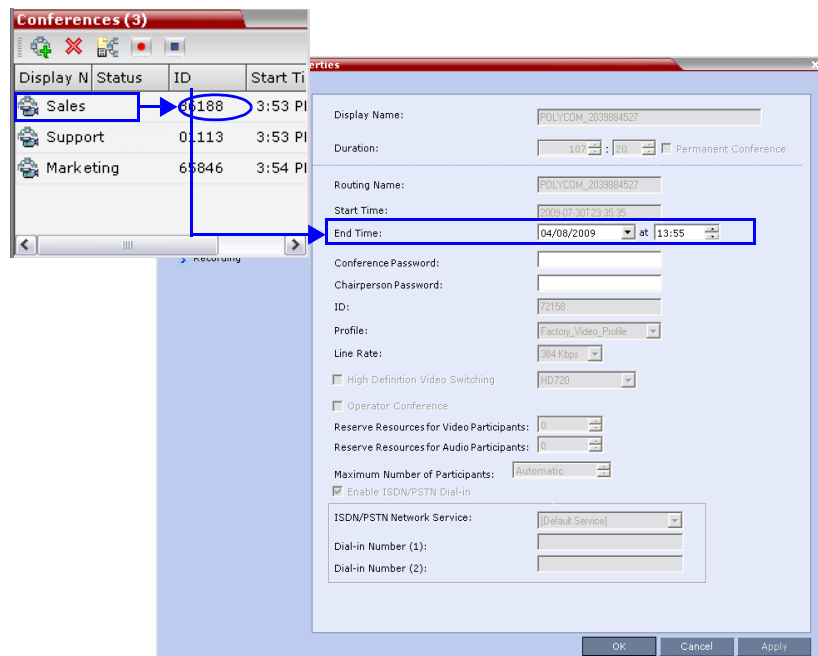

The *End Time* is changed and the *Duration* field is updated.

To terminate a conference manually:

- 1 In the *Conferences* list, select the conference you wish to delete and click the **Delete Conference** (X) button.

You are prompted for confirmation.

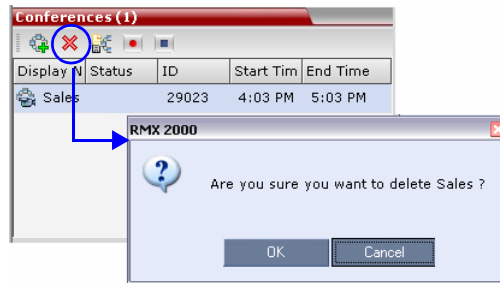

- 2 Click **OK** to terminate the conference.

Adding Participants from the Address Book

Once the conference has started, you can add participants to a conference directly from the *Participants Address Book* without having to use the *New Conference - Participants* tab.

To drag & drop participants into the Participants List:

- 1 Open the *Address Book*.
- 2 Select, drag and drop the participant that you wish to add to the conference directly from the *Participant Address Book* into the *Participant List*.

Standard Windows multiple selection techniques can be used in this procedure.

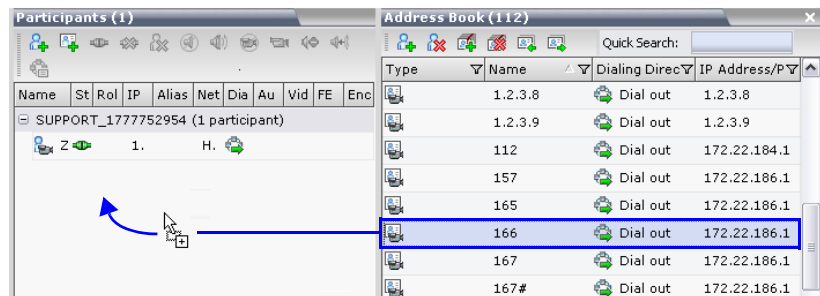

Moving Participants

RMX users can assist participants by performing the following operations:

- Move a participant to an *Operator conference* (Attend a participant).
- Move a participant to the Home (destination) conference.
- Move participant from one ongoing conference to another

A move can be performed using the following methods:

- Using the participant right-click menu
- Using drag and drop

To move a participant from the ongoing conference using the right-click menu options:

- 1** In the *Conferences* list, click the conference where there are participants waiting for *Operator's Assistance* to display the list of participants.
- 2** In the *Participants* list, right-click the icon of the participant to move and select one of the following options:

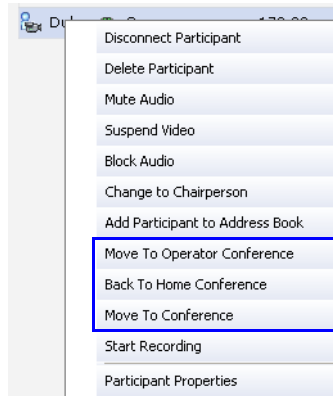

- **Move to Operator Conference** - to move the participant to the Operator conference
- **Move to Conference** - to move the participant to any ongoing conference.

When selected, the *Move to Conference* dialog box opens, letting you select the name of the destination conference.

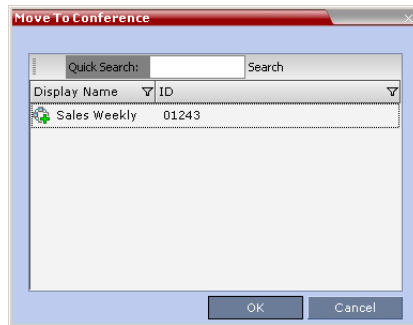

- **Back to Home Conference** - if the participant was moved to another conference or to the *Operator conference*, this options moves the participant back to his/her source conference. This option is not available if the participant was moved from the Entry Queue to the *Operator conference* or the destination conference.

Moving a Participant Interactively

You can drag and drop a participant from the Entry Queue or ongoing conference to the Operator or destination (Home) conference:

- 1 Display the participants list of the Entry Queue or the source conference by clicking its entry in the *Conferences* list.
- 2 In the Participants list, drag the icon of the participant to the *Conferences List* pane and drop it on the *Operator Conference* icon or another ongoing conference.

Saving an Ongoing Conference as a Template

Any conference that is ongoing can be saved as a template.

To save an ongoing conference as a template:

- 1 In the *Conferences List*, select the conference you want to save as a Template.
- 2 Click the **Save Conference** (📄) button.
or
Right-click and select **Save Conference**.

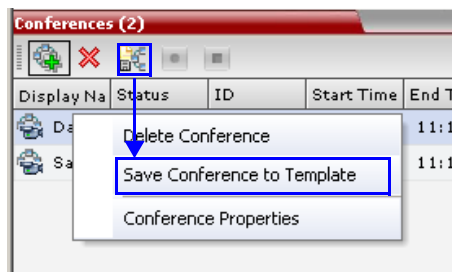

The conference is saved to a template whose name is taken from the ongoing conference *Display Name*.

Copy and Paste Conference

The RMX user can **Copy**, and **Paste** conferences. When using the *RMX Web Client*, conferences can be copied and pasted on the same RMX, however when using the *RMX Manager*, with its ability to manage multiple RMXs, conferences can be copied and pasted between different RMXs.

Copy Conference

The **Copy** command copies all the conference's properties including connected participants and makes these properties available for pasting, starting a new conference. The copied conference remains active until it terminates or is deleted.

To copy a conference:

- 1 In the *Conferences List* pane, right-click the conference you want to copy.

- 2 In the drop-down menu select **Copy Conference**.

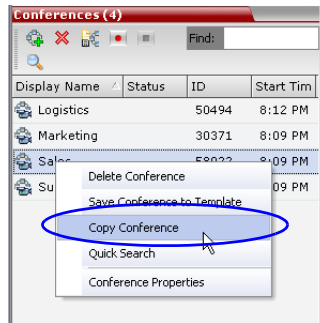

Paste Conference

The **Paste Conference** command starts the new conference on the same *RMX* or on a different *RMX*.

To paste a conference:

- >> Right-click in the *Conferences List* pane and in the drop-down menu select

Paste Conference.

or

If you are using the *RMX Manager* and you want to paste the conference to a different *RMX*:

- In the *MCUs* list pane, click the *RMX* that is to receive the conference.

- b** In the *Conferences* list pane, right-click, and in the drop-down menu select **Paste Conference**.

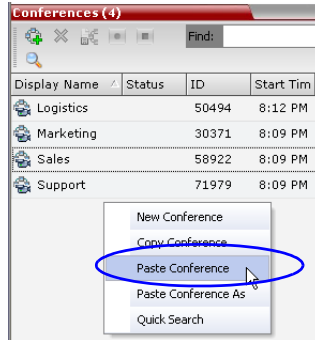

The conference is pasted to the *RMX* with a *Display Name* is assigned by the system.

Paste Conference As

The **Paste Conference As** command allows the *RMX* user to create a new conference using the copied conference's properties as a template. It automatically opens the *Conference Properties* dialog box allowing the *RMX* user to modify the *General*, *Participants* and *Information* tabs to create the new conference. When the **OK** button in the *Conference Properties* dialog box *conference Properties* dialog box is clicked the new conference is started.

To paste a conference as a new conference:

- 1** Right-click in the *Conferences List* pane and in the drop-down menu select **Paste Conference As**.

or

If you are using the *RMX Manager* and you want to paste the conference to a different *RMX*:

- a** In the *MCUs* list pane, click the *RMX* that is to receive the conference.

- b** In the *Conferences* list pane, right-click, and in the drop-down menu select **Paste Conference As**.

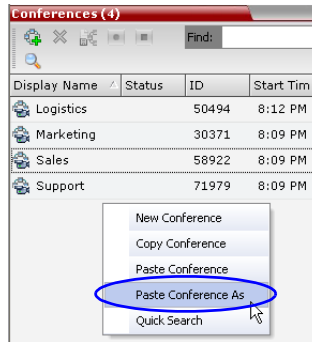

The *Conference Properties* dialog box is displayed.

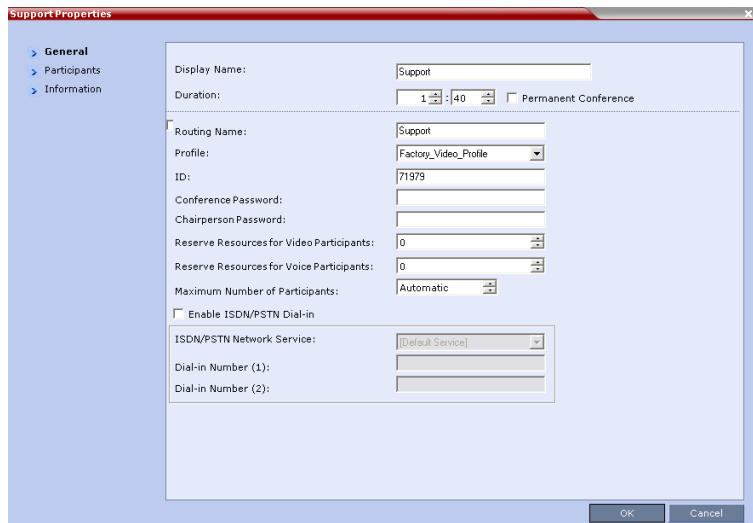

- 2** Modify the conference information as required.
- 3** Click the **OK** button to paste and start the new conference.

Changing the Video Layout of a Conference

While the conference is running, you can change the video layout and select one of 24 video layouts supported by the RMX.

Video Layout selection can be done in two levels:

- **Conference Level** – Applies to all conference participants. All participants have the same video layout.
- **Participant Level** – The participant’s video layout is changed. All other conference participants’ video layouts are not affected.

The initial video layout is selected for the conference in the *Conference Profile*.

Participant level video layout selection overrides conference level video layout settings.

To change the video layout of a conference:

- 1 In the *Conference Properties* dialog box, select **Video Settings**.

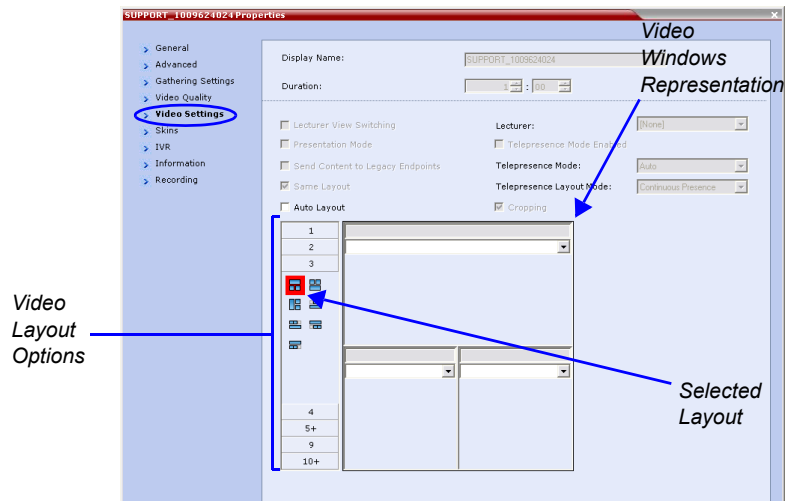

- 2 If the **Auto Layout** check box is selected, clear it.

- 3 From the *Video Layout* options, select the *Number of Windows* to display and the *Video Layout* thumbnail required and click **OK**.

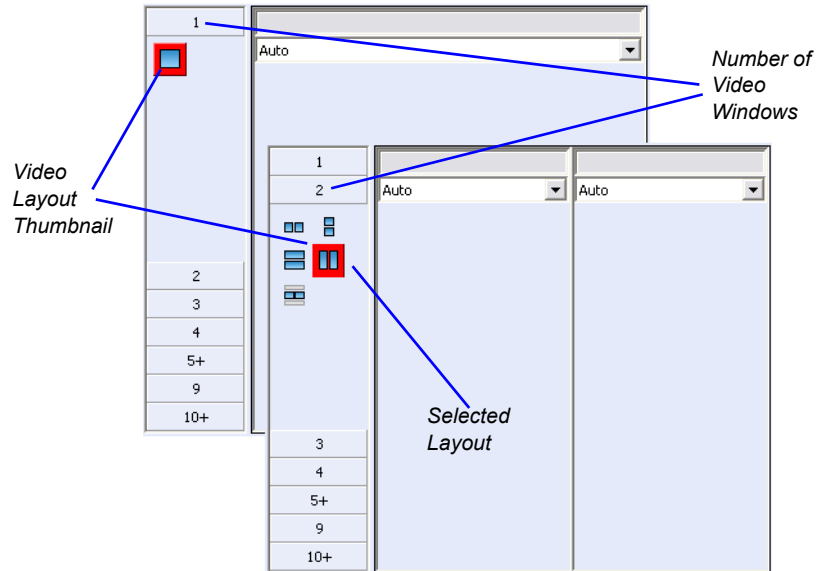

Video Forcing

Users with Chairperson or Operator permission can select which participant appears in each of the video layout windows using *Video Forcing*. When a participant is forced to a layout window, switching between participants is suspended for that window and only the assigned participants is viewed. Video Forcing works on Conference Level or Participant Level:

- **Conference Level** – When forcing a participant to a window, all conference participants will see that participant in the selected window.
- **Participant Level** – When forcing a participant to a window, only the participant's video layout display is affected. All other participants see the conference layout.

Video Forcing Guidelines:

- A participant cannot appear in two or more windows at the same time.

- Participant level video forcing overrides conference level video forcing.
- A participant can view him/herself in a layout window, by selecting the *Same Layout* option.
- When different size video windows are used in video layouts such as 1+2, 1+3, 1+4, etc., a participant can only be forced, in *Personal Layout*, to a video window of the same size as that selected for him/her in *Conference Layout*.
- When changing the Video Layout at the conference level, the video forcing settings are not applied to a new layout, and switching between participants is audio-activated. The video forcing setting are saved and applied the next time the layout is selected.
- Windows that are not assigned any participant display the current speaker and last speakers.

To video force a participant to a window:

- 1 In the *Conference Properties* dialog box, select the **Video Settings** tab.
- 2 If **Auto Layout** check box is selected, clear it.
- 3 Select the required video layout.
- 4 In the window to which you want to force a participant, select the participant's name from the list of conference participants.

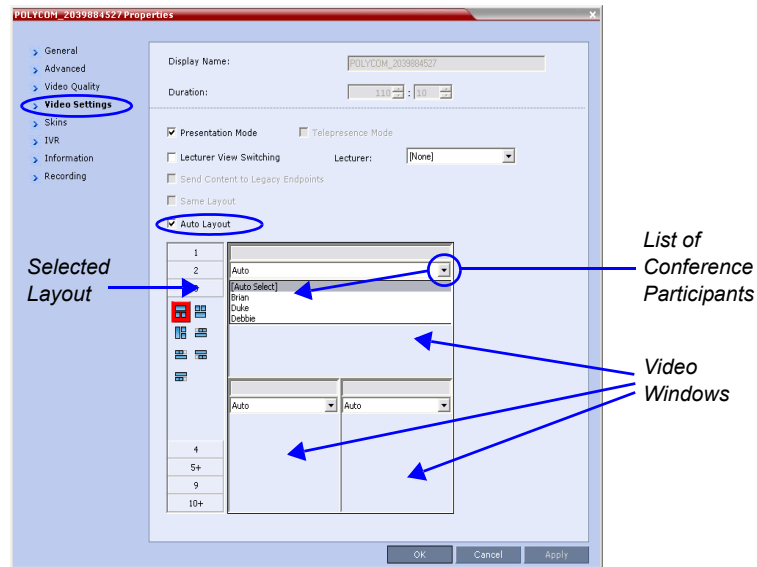

5 Repeat step 3 to force participants to other windows.

6 Click **OK**.

To cancel Video Forcing for a window:

1 In the *Conference Properties* dialog box, select the **Video Settings** tab.

2 In the video layout window, in the *Participants* list, select **Auto**.

3 Click **OK**.

Switching between participants is renewed and is audio activated.

Enabling and Disabling Video Clarity™

The user can enable or disable Video Clarity™ during an ongoing conference.

To enable or disable Video Clarity:

- 1** In the *Conference List* pane, double-click the name of the conference for which you want to enable or disable *Video Clarity* or right-click the conference name and then click **Conference Properties**.
- 2** Click the **Video Settings** tab.
- 3** Select or clear the **Video Clarity** check box as required.
- 4** Click **OK**.

Participant Level Operations

Participant Level Operations enable you to modify and control the connections and statuses of participants in ongoing conferences, as described in Table 3-7.

Table 3-7 *Participant Level Operations*









Menu Option	Button	Description
<i>New Participant</i>		Define a new participant. For more information about the <i>New Participant</i> dialog box tab, see Table 3-3 on page 3-22.
<i>Add Participant From Address Book</i>		Open the <i>Address Book</i> to select the participant for the conference. For more information about the <i>Address Book</i> , see the <i>RMX 1500/2000/4000 Administrator's Guide</i> , "Address Book" on page 5-1.
<i>Connect Participant</i>		Connect a disconnected defined dial-out participant to the conference.
<i>Disconnect Participant</i>		Disconnect the participant from the conference.
<i>Delete Participant</i>		Delete the selected participants from the conference.
<i>Mute Audio</i>		Mute the audio transmission from the participant to the conference. The <i>Audio Muted</i> indicator appears in the <i>Participants List</i> and the <i>Unmute Audio</i> button () becomes active.
<i>Unmute Audio</i>		Resume the participant's audio transmission to the conference. The <i>Mute Audio</i> button () becomes active.

Table 3-7 Participant Level Operations (Continued)









Menu Option	Button	Description
<i>Suspend Video</i>		Suspend the video transmission from the participant to the conference. The suppressed participant's video is not transmitted to the conference but the participant still receives conference video. The <i>Suspend Video</i> indicator appears in the <i>Participants List</i> and the <i>Resume Video</i> button () becomes active.
<i>Resume Video</i>		Resume the participant's video transmission to the conference. The <i>Suspend Video</i> button becomes active ()
<i>Block Audio</i>		To block the audio transmission from the conference to the participant. When blocked, the participant can still be heard by the conference. The <i>Audio Blocked</i> indicator appears in the <i>Participants List</i> and the <i>Unblock Audio</i> button () becomes active.
Unblock Audio		Resume the audio transmission from the conference to the participant. The <i>Block Audio</i> button () becomes active.
<i>Add Participant to Address Book</i>		Add selected participant's details to the <i>Participant Address Book</i> .
<i>Move to Conference</i>		Move the participant to another ongoing conference. The destination conference is selected from a displayed list.
<i>View Participant Sent Video</i>		Preview the video sent from the participant to the conference.
<i>View Participant Sent Video</i>		Preview the video sent from the conference to the participant.

Table 3-7 Participant Level Operations (Continued)

Menu Option	Button	Description
<i>Copy Participant</i>		Copy the all participant's parameters in preparation for Pasting into another conference or back into the current conference..
<i>Cut Participant</i>		Copy the all participant's parameters and delete the participant from the current conference. The participant can be Pasted into another conference or back into the current conference.
<i>Paste Participant As</i>		Paste the participant into the selected conference as a new participant with parameters modified via the Address Book Participant - Properties dialog box.
<i>Abort H.239 Session</i>		To withdraw the Content Token from the participant back to the MCU for re-assignment.
<i>Change to Chairperson</i>		Define the selected participant as the conference leader/chairperson.
<i>Change to Regular Participant</i>		Define the chairperson as a regular participant without chairperson privileges.
<i>Change To Content Token Owner</i>		Initiate <i>Content Broadcast Control</i> to prevent the accidental interruption or termination of <i>H.239 Content</i> that is being shared by this participant. For more information see the <i>RMX 1500/2000/4000 Administrator's Guide</i> , " <i>Content Broadcast Control</i> " on page 2-42 .
<i>Cancel Content Token Owner</i>		Cancel <i>Content Broadcast Control</i> . For more information see the <i>RMX 1500/2000/4000 Administrator's Guide</i> , " <i>Content Broadcast Control</i> " on page 2-42 .
<i>Connect to Website</i>		Connect directly to the internal website of the participant's endpoint to perform administrative, configuration and troubleshooting activities.

Table 3-7 Participant Level Operations (Continued)

Menu Option	Button	Description
AGC (Auto Gain Control)		<p>Enable AGC for the participant with weak audio signal during ongoing conferences.</p> <p>Notes:</p> <ul style="list-style-type: none"> To implement AGC, for the participant audio the ENABLE_AGC System Flag in system.cfg must be set to YES. The flag's default value is NO. For more information see the <i>RMX 1500/2000/4000 Administrator's Guide</i>, "Adding a Participant to the Address Book" on page 5-4. Enabling AGC may result in amplification of background noise.
Participant Properties		<p>To view all <i>Participant Properties</i>.</p> <p>For more information, see the <i>RMX 1500/2000/4000 Administrator's Guide</i>, "Participant Level Monitoring" on page 10-15.</p>

Copy Cut and Paste Participant

The RMX user can **Copy**, **Cut** and **Paste** participants between different conferences running on the RMX, including his/her current conference. These functions, when used via the *RMX Manager*, with its ability to manage multiple RMXs, participants, allows the RMX user to **Copy**, **Cut** and **Paste** participants between conferences running on different RMXs.

Copy Participant

The **Copy** command copies all the participant's properties and makes them available for pasting. The participant remains connected to his/her current conference.

To copy a participant:

- 1 In the *Participants List* pane, right-click the participant you want to copy.

- 2 In the drop-down menu select **Copy Participant**.

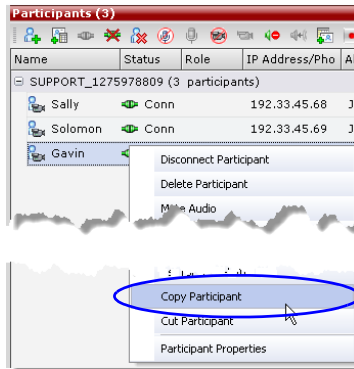

Cut Participant

The **Cut** command copies all the participant's properties and makes them available for *pasting*. The participant is deleted from his/her current conference.

To cut a participant:

- 1 In the *Participants List* pane, right-click the participant you want to cut.
- 2 In the drop-down menu select **Cut Participant**.

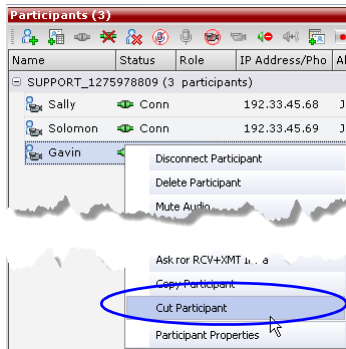

Paste Participant

The **Paste** command connects the *copied* or *cut* participant to the selected conference.

If the participant was *copied*, he/she should be deleted from the conference he/she was *copied* from, unless it is required that the participant is connected to two (or more) conferences. (There are endpoints that permit a participant to be connected to multiple conferences).

To paste a participant:

- 1 In the *Conferences List* pane, click the conference you want to paste the copied/cut participant into.
- 2 Right-click in the *Participants List* pane of the selected conference and in the drop-down menu select **Paste Participant**.

or

If you are using the *RMX Manager* and you want to paste the participant to a conference to different *RMX*:

- a In the *MCUs* list pane, click the *RMX* that is hosting the conference that is to receive the participant.
- b In the *Conferences* list pane, click the conference you want to paste the copied/cut participant into.
- c Right-click, and in the drop-down menu select **Paste Participant**.

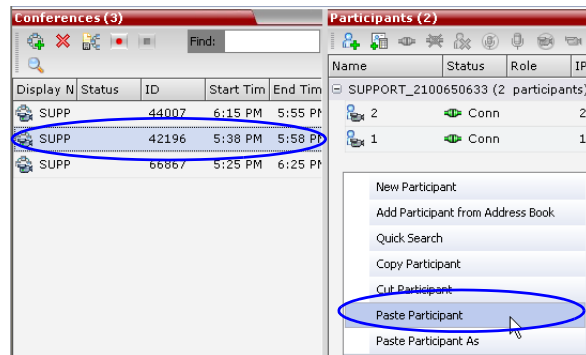

The participant is connected to the conference.

Paste Participant As

The **Paste Participant As** command allows the *RMX* user to create a new participant using the copied participant's properties as a template. It

automatically opens the *Address Book - Participant Properties* dialog box allowing the *RMX* user to modify the participant's properties effectively creating a new participant. When the **OK** button in the *Participant Properties* dialog box is clicked the new participant is connected to the selected conference.

To paste a participant as a new participant:

- 1** In the *Conferences List* pane, click the conference you want to paste the copied/cut participant into.

Right-click in the *Participants List* pane of the selected conference and in the drop-down menu select **Paste Participant As**.

or

If you are using the *RMX Manager* and you want to paste the participant to a conference on another *RMX*:

- a** In the *MCUs* list pane, click the *RMX* that is hosting the conference that is to receive the participant.
- b** In the *Conferences* list pane, click the conference you want to paste the copied/cut participant into.

- c Right-click, and in the drop-down menu select **Paste Participant As**.

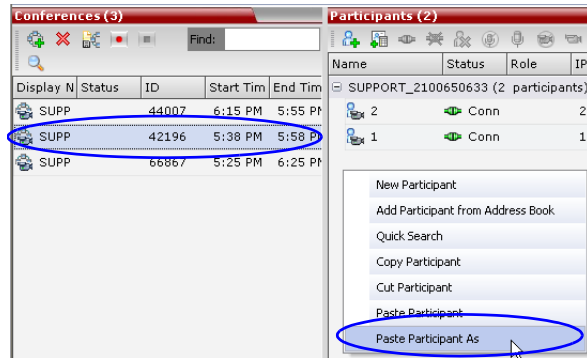

The *Address Book - Participant Properties* dialog box is displayed.

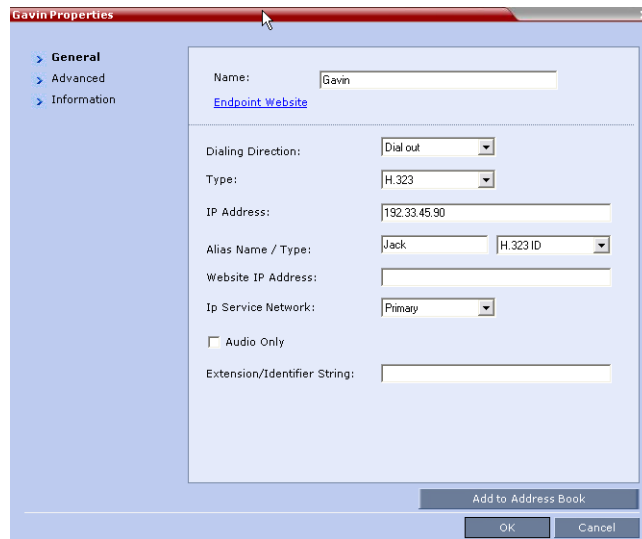

- 2 Modify the participant information as required. For more information see the *RMX 1500/2000/4000 Administrator's Guid"Modifying Participants in the Address Book"* on page 5-14.

Optional. If not already in the *Address Book*, the copied/cut participant can be added to the *Address Book*.

Optional. The new participant can be added to the *Address Book*.

- 3 Click the **OK** button to connect the new participant to the selected conference.

Personal Layout Control with the RMX Web Client

RMX users can use the *RMX Web Client* to change the *Video Layouts* of individual participants and force participants to its windows without affecting the *Video Layouts* of other participants.

To change a participant's Video Layout and Video Forcing:

- 1 In the *Participants* list, double click the participant or right-click the participant and then click **Participant Properties**.

The *Participant Properties – Media Sources* dialog box opens.

- 2 In the *Layout Type* list, select **Personal**.

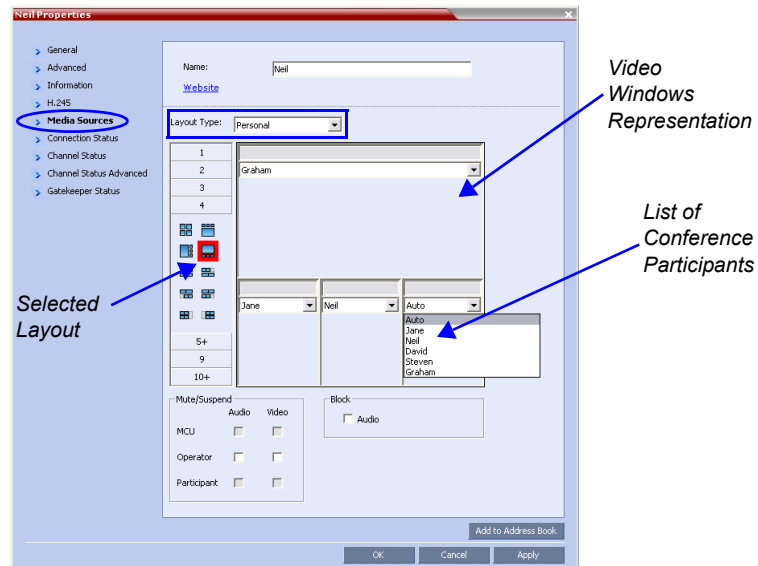

- 3 Select the number of Video Windows.
- 4 Select the required Video Layout.
- 5 To video force participants to windows in the selected video layout, in the window to which you want to force a participant, select the name of the participant to force from the list of conference participants.
- 6 Repeat step 5 to force participants to other windows.
- 7 Click **OK**.

To cancel the Personal Video Layout selection and return to the conference layout:

- 1 In the *Participant Properties* dialog box, select the **Media Sources** tab.
- 2 In the *Layout Type* list, select **Conference**.
- 3 Click **OK**.

The participant will now see the conference video layout with its forced participants.

To cancel the Personal Video Forcing for a window without returning to the conference layout:

- 1 In the *Participant Properties – Media Sources* dialog box, in the video layout window, select **Auto** in the *Participants* list.
- 2 Click **OK**.

Switching between participants is renewed and is audio activated.

Personal Layout Selection with *Click&View*

With the **Click&View** application, participants can change their *Personal Layouts* via *DTMF* codes entered from their endpoints. This option is available only if the **Click&View** option is selected in the *Conference IVR Service*.

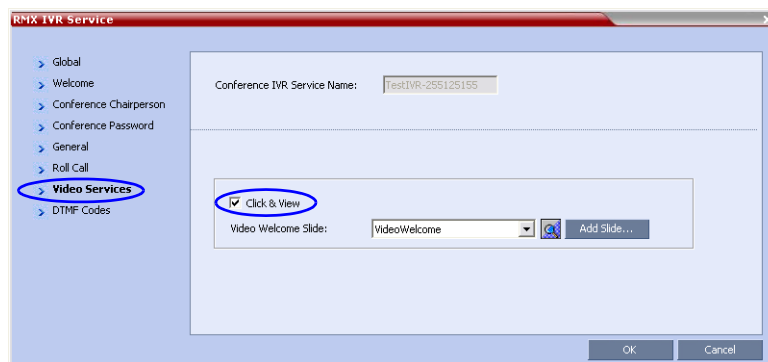

To change Personal Layout with *Click&View*:

- 1 **Enable Click&View** – on the endpoint's keypad, enter .

The *Click&View* application is displayed on the screen.



When using a *Polycom VSX* endpoint, an additional must be entered to enable the remote *DTMF* keypad. The full *Click&View* entry sequence is: .

The Personal Layout keypad options menu is displayed on the video screen.



- 2 On the endpoint's remote keypad, press the number corresponding to the number of video squares you wish to select.

For example, if you want a four-square video layout, press **4**.

The video window layout of your screen changes to the first four-window layout as follows:



Repeated presses of the **4** key, within eight seconds, cycles through the following series of four-square layout options:



























In any multi-square layout, pressing **#** forces the current speaker to the top left window.

In full view, pressing **#** forces the next participant to full view.

In any video layout, pressing **0** reverts to the conference layout.

The following table summarizes the Video Layout options available via *Click&View* .

Table 3-8 Video Layout Options

DTMF Code	Group Default Layout	Group Layout Options
1		
2		  
3		 
4		  
5		 
6		
7		
8		
9		   
0 / 	Revert to the previous conference layout.	

Conference Control Using DTMF Codes

Participants and chairpersons can manage their connection to ongoing conferences from their endpoints, using touch-tone signals (DTMF codes) from their endpoints. Table 3-9 lists the DTMF Codes that can be used.

Chairpersons can also control an ongoing conference using DTMF codes.

Permissions for DTMF actions to be performed by all conference participants or by chairperson only are configured in the *Conference IVR Service* assigned to the conference.

For more information, see the *RMX 1500/2000/4000 Administrator's Guide*, "Defining a New Conference IVR Service" on page [14-9](#).

To use the DTMF codes to control the conference, the DTMF input must be first enabled on the endpoint remote control (for example, entering #).

Table 3-9 Default DTMF Codes to Manage Conferences and Participants

Operation	DTMF String	Permission
Conference help	00	Chairperson
Initiate PCM	##	All
Start Click&View	**	All
Individual help	*0	All
Pause Recording	*1	Chairperson
Stop Recording	*2	Chairperson
Start/Resume Recording	*3	Chairperson
Enable Roll Call	*42	Chairperson
Disable Roll Call	#42	Chairperson
Roll Call Review Names	*43	Chairperson
Roll Call Stop Review Names	#43	Chairperson
Mute All Except Me	*5	Chairperson
Cancel Mute All Except Me	#5	Chairperson
Mute My Line	*6	All
Unmute My Line	#6	All
Secure Conference	*71	Chairperson
Unsecure Conference	#71	Chairperson
Increase Listening Volume	*76	All
Decrease Listening Volume	#76	All

Table 3-9 Default DTMF Codes to Manage Conferences and Participants



Operation	DTMF String	Permission
Change Password	*77	Chairperson
Change To Chairperson	*78	All
Play Help Menu	*83	All
Mute Incoming Participants	*86	Chairperson
Unmute Incoming Participants	#86	Chairperson
Terminate Conference	*87	Chairperson
Show Participants	*88	All
Increase Broadcast Volume	*9	All
Decrease Broadcast Volume	#9	All
Override Mute All	Configurable	All

Requesting Help

A participant can request help using the appropriate DTMF code from his/her touch tone telephone or the endpoint's DTMF input device. The participant can request Individual Assistance (default DTMF code *0) or Conference Assistance (default DTMF code 00).

Participants in Entry Queues who failed to enter the correct destination conference ID or the conference password will wait for operator assistance (provided that an Operator conference is active).

Participant who is waiting for User (Operator) Assistance is displayed with the following icons in the Status column of the Participants pane.

	Awaiting Individual Assistance – The participant has requested the user's (operator's) assistance.
	Awaiting Conference Assistance – The participant has requested the user's (operator's) assistance for the conference. This usually means that the RMX user (operator) has been requested to join the conference.

Personal Conference Manager (PCM)

The *Personal Conference Manager (PCM)* interface enables the conference chairperson to control various conference features using his/her endpoint's remote control device.

The following conference operations can be performed:

- Initiate **Polycom's Click&View™** application to change the local screen layout.
- Invite a participant to connect to the conference.
- View and control the audio and video of each connected endpoint.
- Camera Control - control the camera of a remote endpoint using (*FECC*).
- Control the camera of a connected endpoint.
- Video Force a specific participant to a specific window of the video layout.
- Initiate and control recording of the conference.
- Disconnect a participant.
- Terminate the conference.

Guidelines

- *PCM* is only supported with *MPM+* cards.
- *PCM* is only available in *CP* conferences.
- Although the *RMX* can host up to a maximum of 800 conferences (depending on the *RMX* model) *PCM* can only be activated from 4 conferences per *MPM+* card.
 - An *RMX 2000* with 2 *MPM+80* cards installed can host a total of 8 *PCM* sessions while an *RMX 4000* with 4 *MPM+80* cards installed can host a total of 16 *PCM* sessions.
 - If 4 *PCM* sessions are active on an *MPM+* card and a chairperson of another conference, hosted on the same *MPM+* card, attempts to start an additional *PCM* session, a message indicating insufficient resources is displayed and *FECC* is activated.
- When *PCM* is active, *FECC* can only be performed by the chairperson using *PCM's Camera Control* menu.

- *FECC* is available to all *IP* participants in the conference with the exception of the chairperson that has an active *PCM* session.
- If enabled, *Message Overlay* is not displayed while *PCM* is active.
- Normal conference video is resumed after **4** seconds of inactivity within the *PCM* menu.
- If a chairperson with active *PCM* session is moved to another conference, the *PCM* session is automatically terminated.
- The **PCM_LANGUAGE** *System Flag* determines the language of the *PCM* interface.

Possible Values: ENGLISH, CHINESE_SIMPLIFIED, CHINESE_TRADITIONAL, JAPANESE, GERMAN, FRENCH, SPANISH, KOREAN, PORTUGUESE, ITALIAN, RUSSIAN, NORWEGIAN

Default: Current *RMX Web Client* language.

This *System Flag* must be added to the *System Configuration* file before it can be modified. For more information see the *RMX 1500/2000/4000 Administrator's Guide*, "Modifying *System Flags*" on page **18-5**.

- The *Start PCM DTMF* code for initiating *PCM* is configured in *DTMF Codes* tab of the *New Conference IVR Service* or *Conference IVR Service Properties* dialog box. The default *DTMF Code* is **1** and can be modified if required.

The default value of the *Permission* field is **Everyone**. It can be modified to **Chairperson**.

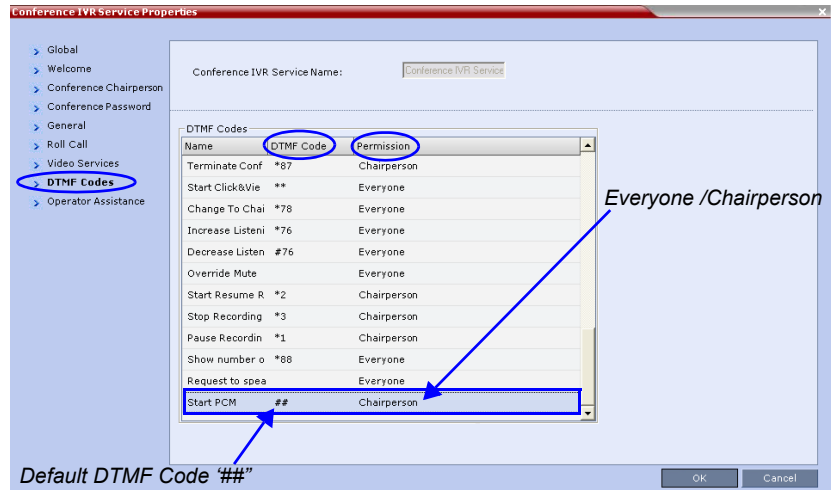

PCM Interface

Initiating PCM

For IP endpoints: PCM is activated by pressing the *Far* key () followed by any of the *Arrow Keys* on the *Remote Control Device*.

For ISDN/PSTN endpoints: PCM is activated by pressing ## on the *Remote Control Device*.

When PCM becomes active, the top level of the *PCM Main Menu* is displayed on the conference chairperson's endpoint:

Main Menu - Level 1

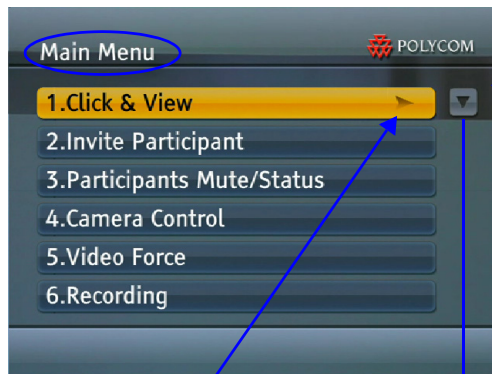

Arrow Indicator:
There are more menu options on the next page

Arrow Indicator:
There are menu options on the previous page

Right Arrow:
Corresponds to the Remote Device's Right Arrow Key
Action:
Go to Sub-Menu of Selected Option (Click&View)

Main Menu - Level 2

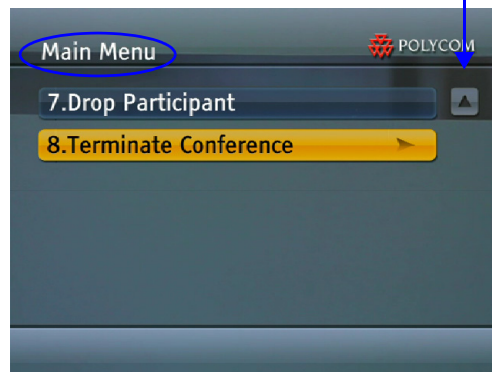

PCM Main Menu - Level 2 can only viewed and accessed by ISDN endpoints by using DTMF Codes 7 and 8.

Remote Control Device Keys

PCM facilitates user interaction with the RMX using *DTMF Codes* and the *Arrow (FECC)* keys of the endpoint's remote control device.

Menu Navigation - Arrow and Zoom Keys

The *PCM Menu* is navigated using the *Remote Device's Arrow Zoom Keys* which are defined as follows:

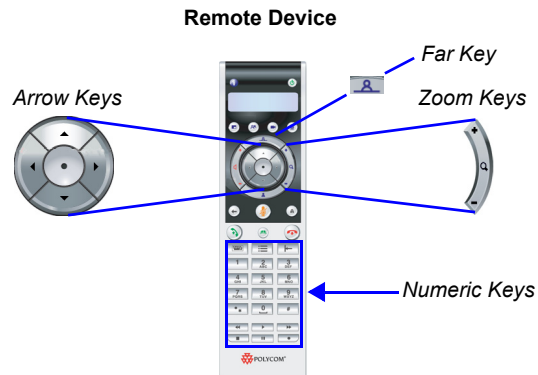



They are defined as follows:

Table 3-10 PCM - Menu Navigation

Arrow Key	Description
<p>Left</p>	<ul style="list-style-type: none"> Go up one menu level. Delete the character to the left of the cursor when entering data. Exit the PCM menu and return to normal conference video (from PCM the top level menu.) Select the video window to the left when navigating a video layout. Initiate PCM from a conference.

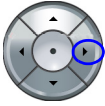
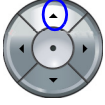
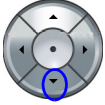
Table 3-10 PCM - Menu Navigation

Arrow Key	Description
<p>Right</p> 	<ul style="list-style-type: none"> • Go down one menu level. • Confirm current selection in the PCM menu. • Select the video window to the right when navigating a video layout. • Initiate PCM from a conference.
<p>Up</p> 	<ul style="list-style-type: none"> • Cycle upward through the displayed menu options. • Select the video window above when navigating a video layout. • Initiate PCM from a conference.
<p>Down</p> 	<ul style="list-style-type: none"> • Cycle downward through the displayed menu options. • Select the video window below when navigating a video layout. • Initiate PCM from a conference.
<p>Zoom in (+)</p> 	<ul style="list-style-type: none"> • Confirm current selection in the PCM menu. • Zoom in on the remote camera when using FECC.
<p>Zoom out (-)</p> 	<ul style="list-style-type: none"> • Exit PCM Menu. • Zoom out on the remote camera when using FECC.

DTMF Codes - Numeric Keys



Before using the shortcut number keys 0-9, enable the DTMF function of the endpoint according to that endpoint's configurations.

DTMF codes are entered using the *Remote Device Numerics Keys* and are defined as follows:

Table 3-11 PCM - DTMF Codes

Numeric Key	Description
0	<ul style="list-style-type: none"> • Number input. • Shortcut key to a numbered menu option - when conference video or the PCM menu is displayed. • Return to the conference - when in FECC mode.
1-9	<ul style="list-style-type: none"> • Number input. • Shortcut key to a numbered menu option - when the conference video or the PCM menu is displayed. • Initiate PCM session on ISDN/PSTN endpoint (1 is the default for the <i>Start PCM</i> DTMF Code).
*	<ul style="list-style-type: none"> • Initiate DTMF mode (with Polycom endpoints) - during a conference or when the PCM menu is displayed. • Enter a period "." - while entering an IP address.
#	Confirm selection and send information to the RMX.

PCM Main Menu - Level 1

Click&View

With the *Click&View* application, participants can change their *Personal Layouts* using the *Arrow Keys* or *DTMF* codes entered using the *Numeric Keys* of their endpoints.

For a full description of *Click&View* see "*Personal Layout Selection with Click&View*" on page **3-82**.

Invite Participant

This function is not available to chairpersons using *PCM* with *ISDN* endpoints.

To invite a participant to connect to the conference:

- 1** Use the **Up/Down** arrow keys to select **Invite Participant** in the *Main Menu* and then press the **Right** arrow or **#** key to confirm your selection.

or

Press the **2** key on the *Remote Device*.

The *Invite Participant* sub menu is displayed.

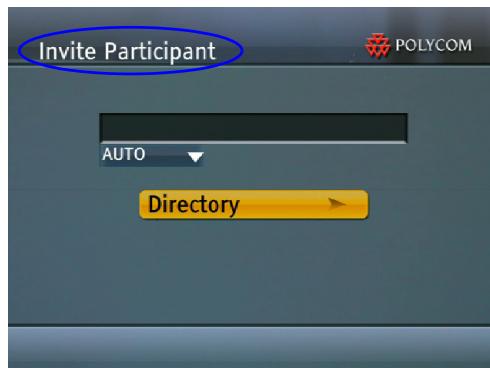

- 2** Use the *Numeric Keys* to enter the number of the participant's endpoint.
- 3** Press the **#** key to initiate the call.
- 4** **Optional.**
 - a** Use the **Down** arrow to select the **Auto** button to select from the following dialing methods:

- H.323
- SIP
- VoIP
- ISDN
- PSTN

b Press the # key to initiate the call.

5 Optional.

a Use the *Arrow Keys* to select the **Directory** button to select the *Alphabetic Grouping* sub menu.

The *Local Directory* is displayed.

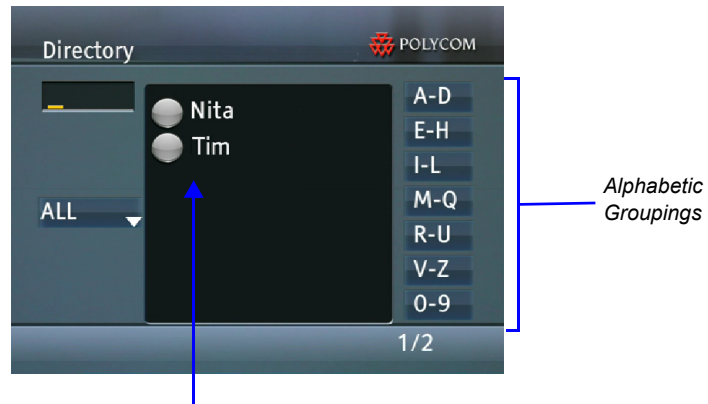

Participant List

b Use the *Numeric Keys* to enter the number of the participant's endpoint.

c Press # or the **Zoom In** key to initiate the call.

or

d Use the **Up/Down** arrow keys to select a **Participant** from the displayed list or use the **Up/Down** and **Left/Right** arrow keys to display other directory listings.

A message, *Press # or Zoom In to select*, is displayed.

e Press # or the **Zoom In** key to initiate the call.

Optional. To display all participants:

a Use the **Down** arrow and the to select the **ALL** button.

b Use the **Zoom In** key to display the global directory.

- c Use the **Up/Down** and **Left/Right** arrow keys to select a **Participant**.
- d Press **#** or the **Zoom In** key to initiate the call.

Participants Mute/Status

This function is not available to chairpersons using *PCM* with *ISDN* endpoints.

The chairperson can view and control the audio and video status of each participant's endpoint. The chairperson can:

- View the audio and video status of participants.
- Mute, block, unmute, unblock participant audio.
- Suspend or allow participant video.
- Mute all (except chairperson and lecturer).

To view and change the Participants Mute/Status:

- 1 Use the **Up/Down** arrow keys to select **Participants Mute/Status** in the *Main Menu* and then press the **Right** arrow or **#** key to confirm your selection.

or

Press the **3** key on the *Remote Device*.

The *Participants Mute/Status* sub menu is displayed.

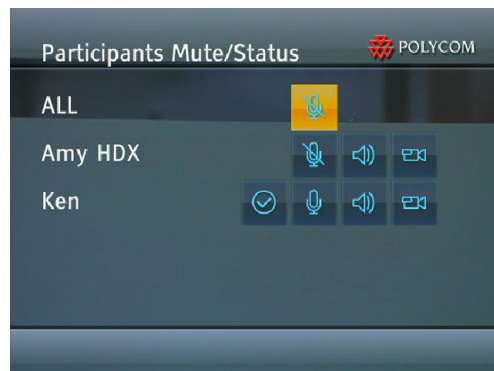









The sub menu displays the *Muted*, *Blocked* and *Video Suspended* status of all participants' endpoints. **ALL** can be selected to mute and unmute all participant endpoints with the exception of the conference chairperson and lecturer.

- 2 Use the **Up/Down/Left/Right** arrow keys to select a *Mute*, *Block* or *Suspend* status icon.
- 3 Use the **Zoom In** key to toggle the state of the audio and video channels of the participants' endpoints.

The status icons are summarized in Table 3-12.

Table 3-12 Participants Mute/Status - Icons

Status Icon	Description
	Audio output from this endpoint is allowed. Other conference participants can hear the audio from this endpoint.
	The endpoint is muted. Other conference participants will not hear audio from this endpoint.
	The audio input to this endpoint is allowed. This endpoint can hear the conference audio.
	The audio output to this endpoint is blocked. This endpoint cannot receive the conference audio.
	Video output from the endpoint is allowed. Other conference participants can see video from this endpoint.
	Video output from the endpoint is suspended. Other conference participants cannot see video from this endpoint.
	The endpoint is neither muted nor blocked.
	The endpoint is both muted and blocked.

Camera Control

This function is not available to chairpersons using *PCM* with *ISDN* endpoints.

The endpoint to be controlled must support *Far End Camera Control* (FECC).

Using the arrow keys of the remote control device, the chairperson can control the direction, zoom and focus of a remote endpoint's camera.

To control a far camera:

- 1 Use the **Up/Down** arrow keys to select **Camera Control** in the *Main Menu* and then press the **Right** arrow or **#** key to confirm your selection.

or

Press the **4** key on the *Remote Device*.

The *Camera Control* sub menu is displayed.

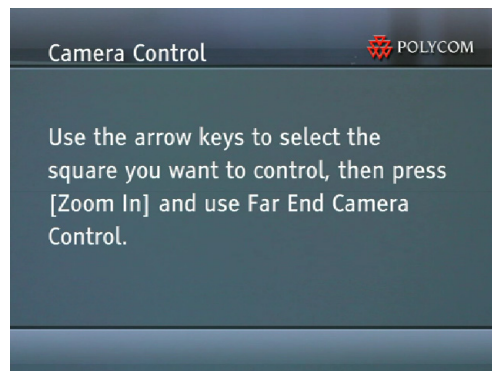

- 2 Use the **Up/Down/Left/Right** arrow keys to select the far camera to be controlled.
A colored frame is displayed around the selected cell in the video layout.
- 3 Use the **Zoom In** key to activate *FECC*.

Following a 10 second delay, the *FECC* active icon () is displayed in the video image of the selected site.

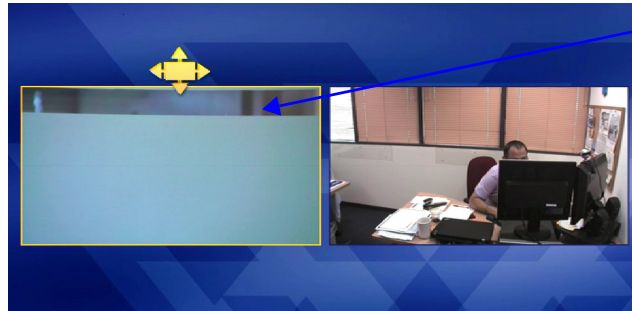

*Selected Cell for
Far End
Camera Control*

- 4** Use the **Up/Down/Left/Right/Zoom In/Zoom Out** arrow keys to control the remote camera.
- 5** Press the **0** key on the remote control to exit FECC.
- 6** Use the **Zoom Out** key on the remote control to return to the conference video.

Video Force

This function is not available to chairpersons using *PCM* with *ISDN* endpoints.

Video Force enables the chairperson to force the video of a specific participant to a specific window of the video layout.

To Video Force a participant's video:

- 1** Use the **Up/Down** arrow keys to select **Video Force** in the *Main Menu* and then press the **Right** arrow or **#** key to confirm your selection.

or

Press the **5** key on the *Remote Device*.

The *Video Force* sub menu is displayed.

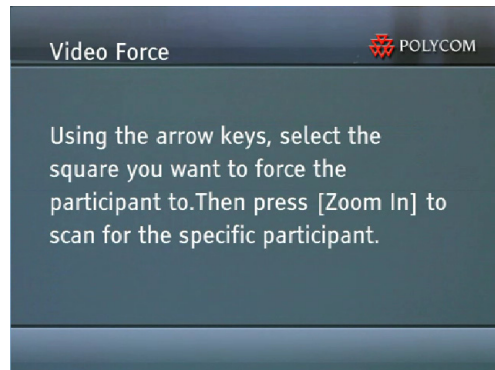

- 2** Use the **Up/Down/Left/Right** arrow keys to select the window of the video layout that you want the specific participant to be displayed in.
- 3** Press the **Zoom In** key to cycle the display of all participants in the selected video window until the participant you want to be displayed appears.
- 4** Press the **Right** arrow or **#** key to confirm your selection.

Recording

This function is not available to chairpersons using *PCM* with *ISDN* endpoints.

If a *Recording Link* has been set up in the *Conference Profile*, the conference chairperson can use the *PCM* interface to start, pause, resume and stop recording. If no *Recording Link* exists, this function appears grayed out and cannot be selected.

To use the recording functions:

- 1 Use the **Up/Down** arrow keys to select **Recording** in the *Main Menu* and then press the **Right arrow** or **#** key to confirm your selection.

or

Press the **6** key on the *Remote Device*.

The *Recording* sub menu is displayed.

**To start recording:**

- ① Use the **Up/Down** arrow keys to select **Start Recording** and then press the **Right arrow** or **#** key to confirm your selection.

or

Press the **1** key on the *Remote Device*.

To pause recording:

- ① While recording is in progress, use the **Up/Down** arrow keys to select **Pause** and then press the **Right arrow** or **#** key to confirm your selection.

or

Press the **2** key on the *Remote Device*.

To resume recording:

- ① While recording is paused, use the **Up/Down** arrow keys to select **Resume** and then press the **Right arrow** or **#** key to confirm your selection.

or

Press the **2** key on the *Remote Device*.

To stop recording:

- ① While recording is in progress, use the **Up/Down** arrow keys to select **Stop Recording** and then press the **Right** arrow or **#** key to confirm your selection.

or

Press the **3** key on the *Remote Device*.

PCM Main Menu - Level 2

Drop Participant

To disconnect a participant from the conference:

- 1** Use the **Up/Down** arrow keys to navigate to the second page of the *Main Menu*
- 2** Use the **Up/Down** arrow keys to select **Drop Participant** and then press the **Right** arrow or **#** key to confirm your selection.

or

Press the **7** key on the *Remote Device*.

The *Drop Participant* sub menu is displayed.



- 3** Using the **Up/Down** arrow keys, select the participant to be disconnected and then press the **Right** arrow or **#** key to confirm your selection.

or

Press the *Numeric Key* on the *Remote Device* corresponding to the participant entry.

Terminate Conference



Although this function can be accessed and viewed by chairpersons using *PCM* with *ISDN* endpoints, conference termination cannot be executed.

Although this function can be accessed and viewed by chairpersons using *PCM* with *ISDN* endpoints, conference termination cannot be executed.

To terminate a conference:

- 1 Use the **Up/Down** arrow keys to navigate to the second page of the *Main Menu*
- 2 Use the **Up/Down** arrow keys to select **Terminate Conference** and then press the **Right** arrow or **#** key to confirm your selection.

or

Press the **8** key on the *Remote Device*.

The *Terminate Conference* sub menu is displayed.

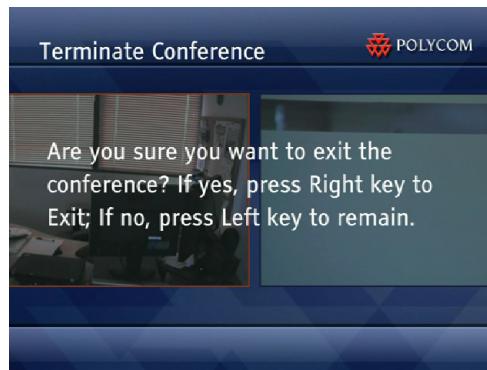

- 3 Press the **Right** arrow key to confirm termination of the conference.
- or
- Press the **Left** arrow key to cancel termination of the conference.

Appendix A

Glossary

This appendix lists the terms and abbreviations that are related to the Polycom RMX 1500/2000/4000, and are commonly used in the RMX documentation.

Abbreviation/ Term	Explanation
<i>AGC</i>	Auto Gain Control. A mechanism that regulates noise and audio volume by keeping the received signal of all participants balanced.
<i>Bandwidth</i>	Defines the information carrying capacity of a channel. In analog systems, it is the difference between the highest frequency that a channel can carry and the lowest, measured in hertz. In digital systems, bandwidth is measured in bits per second. The larger a connection's bandwidth, the more data can be transmitted in a given amount of time, allowing for greater video resolution and more sites in a conference. For more information, see Line Rate.
<i>Bonding</i>	Bandwidth ON Demand INterpolarity Group. A transmission protocol that aggregates two 64 Kbps B channels to function as one 128 Kbps channel. When using several BRI channels, Bonding means that only one D-channel serves all BRI channels, while the remaining D-channels are used for data transfer. See also: BRI.
<i>Bps, Kbps</i>	Bits and kilobits per second; a unit of bandwidth, which is the amount of data that can flow during one second over a communications line (using a transmission medium). 1 Kbps = 1000 Bps

Abbreviation/ Term	Explanation
<i>BRI</i>	Basic Rate Interface. A type of ISDN connection for transiting data, consisting of 3 channels: two B-channels (each of 64 Kbps) and one D-channel (16 Kbps).
<i>Carrier</i>	A telephone or other company that provides telecommunication transmission services.
<i>CIF, 4CIF, QCIF</i>	Common Intermediate Format, an optional part of the ITU-T's H.261 and H.263 standards. CIF specifies 288 non-interlaced luminance lines, that contain 176 pixels. CIF can be sent at frame rates of 7.5, 10, 15, or 30 per second. When operating with CIF, the amount of data to transmit cannot exceed 256 K bits (where K equals 1024).The CIF video format has the capacity to transmit video images of 352x288 pixels at 36.45 Mbps and 30 frames per second. A 4CIF format has four times the capacity of CIF; QCIF has quarter the capacity of CIF.
<i>Codec</i>	<u>C</u> oder- <u>d</u> ecoder. A device that converts voice and video into digital code, and vice versa. Refers to the endpoint video camera and video board that are used for videoconferencing.
<i>Conference</i>	Connection between two or more endpoints exchanging video and audio information. If only two endpoints are involved, a conference is called <i>point-to-point</i> and no MCU is required. If more than two endpoints are involved, it is called a <i>multipoint</i> conference, and an MCU (Multipoint Control Unit) is required as the management system. For more information, see MCU.
<i>CSU</i>	Channel Service Unit. Customer-provided equipment that is used as an interface between a communication network and the data terminal.
<i>DBA</i>	Dynamic Bandwidth Allocation. Used to allocate the bandwidth needed to transmit the additional packets. for LPR.

Abbreviation/ Term	Explanation
<i>DTMF</i>	Dual Tone Multi Frequency. A system of coded signals used by touch-tone telephones in which a specific sound, frequency or tone is assigned to each key so that the signal can be easily recognized by a computer. The codes enable data input and control of voice-processing systems. DTMF signals can pass through the entire connection to the destination device and therefore are used for remote control after the connection with the MCU is established.
<i>E1 Line</i>	A 2Mb digital switched line used in Europe.
<i>Endpoint</i>	A hardware device, or set of devices, that can call, and be called by an MCU or another endpoint. For example, an endpoint can be a phone, a camera and microphone connected to a PC or an integrated Room System (conferencing system).
<i>FECC</i>	Far End Camera Control. In certain video cameras, the accompanying software that enables a participant to control a remote camera. Used in Continuous Presence video conferences in conjunction with the LSD option. For more information, see LSD.
<i>Frame</i>	A group of bits that make up an elementary block of video data for transmission by certain protocols.
<i>Frame Rate</i>	The number of video frames displayed on-screen during one second, measured in fps (frames per second).
<i>G.711</i>	ITU-T audio algorithm, 64Kbps, 3.4 kHz.
<i>G.722</i>	ITU-T audio algorithm, 64Kbps, 7 kHz.
<i>G.728</i>	ITU-T audio algorithm, 16Kbps, 3.4 kHz.
<i>Gatekeeper</i>	A type of server that performs two main functions: translates LAN alias addresses of terminals and gateways to IP addresses and provides bandwidth management.
<i>H.221</i>	ITU-T standard that defines how to multiplex video, audio, control, and user data into one serial bit stream.

Abbreviation/ Term	Explanation
<i>H.230</i>	ITU-T standard that defines simple multipoint control systems procedures and describes network maintenance functions.
<i>H.231</i>	ITU-T standard that defines a set of MCU functions and operational requirements.
<i>H.242</i>	ITU-T standard that defines initiation of communications between systems and capabilities negotiation procedures.
<i>H.243</i>	ITU-T standard that defines initiation of communications between systems and capabilities negotiation procedures in multipoint conferences.
<i>H.261</i>	ITU-T standard that defines the Px64 video coding algorithm.
<i>H.263</i>	ITU-T standard that provides improved compression and quality of video images at a line rate lower than 384 Kbps. This standard is not supported by all codecs.
<i>H.264*</i>	A proprietary Polycom Video compression standard.
<i>H.264</i>	ITU-T standard that provides improved compression and quality of video images in lower line rate connections and is part of the Highest Common mechanism in Video Switching conferences.
<i>H.320</i>	ITU-T standard that defines how the H-series video conferencing recommendations work together.
<i>H.323</i>	ITU-T standard for audio, video and data communications across IP-based (LAN) networks, including the Internet.
<i>ICE</i>	Interactive Connectivity Establishment (ICE) provides a structure/protocol to unify the various NAT Traversal techniques that are used to cross firewalls. It enables SIP based endpoints to connect while traversing a variety of firewalls that may exist between the calling endpoint (local) and the MCU or called endpoint (remote).
<i>IP</i>	Internet Protocol. The working protocol that forms the basis of the internet.

Abbreviation/ Term	Explanation
<i>ISDN</i>	Integrated Services Digital Network. A set of protocol and interface standards (voice, video and data) that comprise a telephone network. There are two types of ISDN lines: BRI and PRI.
<i>ITU-T Standard</i>	International Telecommunications Union, Telecommunication Standardization Sector (formerly CCITT). An international group that produces official standards for telecommunications.
<i>LAN</i>	Local Area Network. A group of computers and other devices linked via a network's operating system.
<i>LDAP</i>	Lightweight Directory Access Protocol.
<i>Line Rate</i>	The amount of bandwidth used by a communication device, measured in Kbps (kilobits per second).
<i>LPR</i>	Lost Packet Recovery. An algorithm that creates additional packets that contain recovery information necessary to reconstruct lost packets.
<i>MCU</i>	Multipoint Control Unit. Device which allows more than two sites to be connected in a video conference.
<i>Null modem cable</i>	A serial cable designed to eliminate the need for communication equipment when two digital devices are directly connected to each other.
<i>Participant</i>	A person using an endpoint to connect to a conference. When using a Room System, several participants use a single endpoint.
<i>PRI</i>	Priority Rate Interface. An ISDN interface designed for high volume data communication. Consists of 23 B channels of 64 Kbps each and one D channel of 64 Kbps. In Europe, the PRI line provides 30 B channels + one D channel.
<i>PSTN</i>	Public Switched Telephone Network.

Abbreviation/ Term	Explanation
<i>QCIF</i>	Quarter CIF. A video format with image size of 176x144 pixels that transmits 9.115 Mbps at 30 frames per second (a quarter of the capacity of CIF). For more information, see CIF.
<i>QoS</i>	Quality of Service. QoS defines the performance of a network service, such as the average delay between packets.
<i>RS-232</i>	A standard for serial interface connection.
<i>SIP</i>	Session Initiation Protocol. An application-layer protocol designed to work over IP networks. A SIP service defines the properties and the IP addresses of the SIP network components.
<i>Span</i>	An ISDN line or leased line. A span may be of either T1 (United States) or E1 (Europe) type. Also called a circuit.
<i>SRTP</i>	Encryption of SIP Media is supported using SRTP (Secured Real-time Transport Protocol) and the AES key exchange method.
<i>T1 Line</i>	A 1.5Mb digital switched line used in the United States.
<i>ToS</i>	Type of Service. ToS defines optimization tagging for routing audio and video packets.
<i>WAN</i>	Wide Area Network. A communications network that services a geographical area larger than the LAN.
<i>Whiteboard</i>	An on-screen shared notebook for placement of shared documents.